

# Guideline on: Groundwater monitoring for general reference purposes

International Working Group I

Utrecht  
June 2006

Revised March 2008

## **Acknowledgements**

The publication of the Guideline was made possible by the generous support of international and Dutch organisations and by the valuable contributions of professionals from several countries world wide.

The draft version of the Guideline has been published by the International Groundwater Resources Assessment Centre (IGRAC). IGRAC is an initiative of UNESCO and WMO. The Centre is hosted at the Netherlands Organisation of Applied Scientific Research TNO, Utrecht, The Netherlands. For the period 2003 through 2006 IGRAC is financially supported by the Dutch inter-ministerial bureau 'Partners for Water'.

The published guideline is the result of enthusiastic cooperation by a group of professionals from different geographic areas and with expertise in different groundwater related disciplines.

# **Guideline on: Groundwater monitoring for general reference purposes**

*Editor: Gerrit Jousma, IGRAC, The Netherlands*

*With contributions by:*

*Premadasa Attanayake, Bechtel Corporation, USA*

*John Chilton, BGS, United Kingdom*

*Armin Margane, BGR, Germany*

*Carlos Martínez Navarrete, IGME, Spain*

*Maria Teresa Melo, University of Aveiro, Portugal*

*Pedro Nieto López Guerrero, IGME, Spain*

*Maurizio Polemio, CNR-IRPI, Italy*

*Frans Roelofsen, IGRAC, The Netherlands*

*S.K.Sharma, GRI, India*

*Mike Streetly, ESI, United Kingdom*

*Ali Subah, MWI, Jordan*

*Ahmed Al Yaqoubi, PWA, Palestine/Gaza*

Utrecht

June 2006

Revised March 2008

# Table of contents

<b>1</b>	<b>Introduction .....</b>	<b>1</b>
1.1	The guideline - background and rationale .....	1
1.2	Stages in groundwater monitoring.....	1
1.3	Focus and scope of the guideline.....	2
1.4	General outline of the guideline .....	4
1.5	International cooperation.....	6
<b>2</b>	<b>Groundwater monitoring – general aspects and design procedure .....</b>	<b>7</b>
2.1	Groundwater monitoring – concepts and general aspects .....	7
2.2	Proposed design procedure.....	12
2.3	Modular set-up of the groundwater monitoring programme .....	14
2.4	Basic options of monitoring programmes.....	15
<b>3</b>	<b>Groundwater problem identification and preliminary assessments .....</b>	<b>18</b>
3.1	Purpose and approach.....	18
3.2	Preliminary characterisation of the area .....	19
3.3	Preliminary characterisation of the aquifers .....	20
3.4	Preliminary assessment of the groundwater situation.....	22
3.5	Preliminary evaluation of results and specification of key issues .....	26
3.6	Defining a sustainable scale of monitoring .....	28
<b>4</b>	<b>Groundwater system analysis.....</b>	<b>30</b>
4.1	The conceptual model.....	30
4.2	Inventory of data .....	31
4.3	Specification of the hydrogeological framework.....	31
4.4	Analysis of groundwater flow .....	33
4.5	Assessment of groundwater quality.....	36
<b>5</b>	<b>Analysis of institutional setting.....</b>	<b>39</b>
5.1	Institutional embedding of groundwater monitoring .....	39
5.2	Water sector policy and legislation .....	40
5.3	Responsibilities and mandates of water sector institutions and stakeholder groups.....	41
5.4	Required technical capability of water institutions.....	43
5.5	Information exchange and publication of monitoring results .....	43
<b>6</b>	<b>Design of a programme for groundwater quantity monitoring .....</b>	<b>45</b>
6.1	Monitoring objectives and data needs .....	45
6.2	Design of groundwater monitoring to meet identified information needs.....	48
6.3	Considering monitoring options .....	53
6.4	Use of existing wells and planning new ones .....	54

<b>7</b>	<b>Design of a programme for groundwater quality monitoring.....</b>	<b>56</b>
7.1	Monitoring objectives and data needs .....	56
7.2	Design of groundwater monitoring to meet identified information needs.....	57
7.3	Considering monitoring options .....	66
7.4	Use of existing wells and planning new ones .....	66
<b>8</b>	<b>Feasibility of monitoring programme options .....</b>	<b>68</b>
8.1	Documents required .....	68
8.2	Definition and preparation of monitoring programme options.....	69
8.3	Calculation of investments and annual costs .....	69
8.4	Evaluation of groundwater monitoring programme options.....	71
<b>9</b>	<b>Implementation .....</b>	<b>74</b>
9.1	Introduction to the chapter.....	74
9.2	Phase 1: Orientation and inception .....	74
9.3	Phase 2: Design of the monitoring programme .....	75
9.4	Phase 3: Implementation of the monitoring programme improvements.....	75
9.5	Phase 4: Organisation of monitoring and sampling .....	76
<b>10</b>	<b>Data management: storage, processing and validation .....</b>	<b>77</b>
10.1	Introduction to data management .....	77
10.2	Data storage .....	78
10.3	Data processing .....	80
10.4	Data reporting and presentation.....	81
10.5	Data validation .....	82
	<b>References and related literature.....</b>	<b>88</b>

## Annexes

<b>Annex A: Groundwater monitoring in different hydrogeological settings.....</b>	<b>A-1</b>
<b>Annex B: Selection and installation of wells for groundwater monitoring .....</b>	<b>B-1</b>
<b>Annex C: Water level recording and discharge measurements.....</b>	<b>C-1</b>
<b>Annex D: Groundwater quality sampling .....</b>	<b>D-1</b>
<b>Annex E: Documentation of groundwater monitoring – Examples of standard forms.</b>	<b>E-1</b>
<b>Annex F: Operational costs – Examples from Europe.....</b>	<b>F-1</b>
<b>Annex G: Audits and groundwater monitoring network optimisation .....</b>	<b>G-1</b>
<b>Annex H: An example of groundwater monitoring in Jordan.....</b>	<b>H-1</b>

# Figures

FIGURE 1.1: GENERAL OUTLINE OF THE GUIDELINE .....	4
FIGURE 2.1: THE WATER QUALITY ASSESSMENT CYCLE (AFTER TIMMERMAN, 2000) .....	7
FIGURE 2.2: SCHEME FOR DESIGN OF A GROUNDWATER MONITORING PROGRAMME .....	12
FIGURE 2.3 SHOWS HOW THE MONITORING PROGRAMME CAN BE COMPOSED OF DIFFERENT MONITORING COMPONENTS, EACH LINKED TO ONE OF THE GROUNDWATER MANAGEMENT OBJECTIVES AND THE DATA SETS REQUIRED. ....	14
FIGURE 4.1: SCHEMATIC CROSS-SECTION OF A CONCEPTUAL MODEL.....	32
FIGURE 4.2: SCHEMATIC CROSS-SECTION SHOWING GROUNDWATER FLOW SYSTEMS .....	34
FIGURE 6.1: EXAMPLE OF CATCHMENTS IN COASTAL PLANE.....	48
FIGURE 6.2: EXAMPLE OF CATCHMENTS IN MOUNTAIN VALLEY.....	49
FIGURE 6.3: MONITORING NETWORK OPTION 1 .....	50
FIGURE 6.4: MONITORING NETWORK OPTION 2.....	50
FIGURE 6.5: MONITORING NETWORK OPTION 3.....	50
FIGURE 7.1: NETWORK POSITIONED PERPENDICULAR TO THE COAST .....	60
FIGURE 10.1: HYDROGRAPH OF WELL THAT OCCASIONALLY FALLS DRY .....	85

# Tables

TABLE 1.1: FOCUS AND SCOPE OF THE GUIDELINE .....	3
TABLE 1.2: WORKING GROUP MEMBERS.....	6
TABLE 2.1: ESSENTIAL QUESTIONS CONCERNING INFORMATION NEEDS .....	8
TABLE 2.2: EXAMPLES OF GROUNDWATER MONITORING OBJECTIVES .....	9
TABLE 2.3: EXAMPLE OF DATA NEEDS FROM DIFFERENT DATA SOURCES FOR SPECIFIED OBJECTIVES.....	10
TABLE 3.1: GENERAL DESCRIPTION OF THE AREA CONSIDERED.....	20
TABLE 3.2: AQUIFER ZONES AND NON-AQUIFER ZONES IN THE AREA.....	21
TABLE 3.3: GEOLOGY OF THE AREA.....	21
TABLE 3.4: CHARACTERISTICS OF AQUIFER SYSTEM PER ZONE.....	22
TABLE 3.5: GROUNDWATER QUANTITY SITUATION - PRELIMINARY ESTIMATES.....	23
TABLE 3.6: POTENTIAL CONFLICT SITUATIONS - GROUNDWATER QUANTITY .....	23
TABLE 3.7: OBSERVED TRENDS – GROUNDWATER QUANTITY .....	24
TABLE 3.8: POTENTIAL CONFLICT SITUATIONS - GROUNDWATER QUALITY.....	25
TABLE 3.9: OBSERVED TRENDS – GROUNDWATER QUALITY .....	25
TABLE 4.1: GROUNDWATER BALANCE WITH INFLOW AND OUTFLOW COMPONENTS .....	35
TABLE 6.1: TABLE SHOWING POSSIBLE DIFFERENTIATION OF THE NETWORK DENSITY AND FREQUENCY OF OBSERVATION IN RELATION TO DEPTH AND DEGREE OF CONFINEMENT OF THE AQUIFERS .....	52
TABLE 8.1: EXAMPLE TABLE FOR CALCULATION OF INVESTMENTS OF DIFFERENT PROGRAMME OPTIONS .....	70
TABLE 8.2: EXAMPLE TABLE FOR CALCULATION OF YEARLY COSTS OF DIFFERENT PROGRAMME OPTIONS.....	71
TABLE 8.3: EXAMPLE TABLE FOR EVALUATION OF DIFFERENT OPTIONS – GROUNDWATER QUANTITY MONITORING .....	72

# 1 Introduction

## 1.1 The guideline - background and rationale

Groundwater is a major source of water supply for drinking, irrigation and animal husbandry in many countries, especially in arid and semi-arid regions. It is also a vital element of groundwater dependent ecosystems such as wetlands. Regular and systematic monitoring of groundwater resources is necessary for its effective management to support the water needs of the environment and its citizens.

According to a world-wide inventory of groundwater monitoring compiled by the International Groundwater Resources Assessment Centre (IGRAC), in many countries systematic monitoring of groundwater quantity or quality, even at a regional scale, is minimal or non-existent (Jousma and Roelofsen, 2004). Lack of monitoring may result in undiscovered degradation of water resources either due to over-abstraction or contamination, leading to the following scenarios:

- Declining groundwater levels and depletion of groundwater reserves;
- Reductions in stream/spring base flows or flows to sensitive ecosystems such as wetlands;
- Reduced access to groundwater water for drinking water supply and irrigation;
- Use restrictions due to deterioration of groundwater quality;
- Increased costs for pumping and treatment;
- Subsidence and foundation damage.

A number of factors that contribute to the lack of monitoring can be identified. Lack of financial resources and lack of technical capacity to implement monitoring are perhaps the major factors. Other factors that may contribute are a lack of clear institutional responsibilities and legal requirements for monitoring. Even where monitoring programmes are operating, they may fail to provide adequate information to support effective management because:

- The objectives are not properly defined;
- The programme is established with insufficient knowledge of the groundwater system;
- There is inadequate planning of sample collection, handling and storage;
- Data are poorly archived and not readily accessible in the type of formats that can be used to support management and inform other stakeholders.

Several guidelines for the development of groundwater monitoring are available. However, most of them have not adequately addressed the early stages of groundwater monitoring, which are often characterised by poor hydrogeological information, limited financial resources and/or limited institutional capacity. In order to improve this situation, IGRAC assembled an international working group of groundwater professionals and gave it the task of developing a groundwater monitoring guideline for countries with limited financial resources. The guideline presented in this document is the result of concerted action by the working group. The guideline focuses on the first stage of groundwater monitoring for general reference, a prerequisite for sound groundwater management. The guideline is intended to be complementary to existing publications.

## 1.2 Stages in groundwater monitoring

In the development of groundwater monitoring, networks of different types, size and functions can be distinguished. With respect to the size of groundwater monitoring networks, one can distinguish between large “regional” (sub-national) networks and “local” networks. Regional monitoring networks are usually designed to characterise and monitor regional groundwater systems of large extent and importance while local networks focus on more detailed observation of the local

groundwater situation, such as around well fields or point sources of pollution such as landfills or industrial sites.

In the early stage of groundwater assessment, when information regarding the groundwater resources is still very scarce, assessment and monitoring will usually be aimed at regional assessment of groundwater resources and their potential for development. When financial resources are limited, groundwater observation or sampling will usually be done at any suitable observation point available. Hence the initial network often has an improvised set-up.

Improvements to the initial network for regional monitoring can be achieved by selecting suitable observation points from the initial round of data collection and by adding new points in gaps of the network where additional information is crucial. In this way large capital costs can still be avoided. Such a large-size groundwater monitoring network, primarily aimed at monitoring the status and trends of regional groundwater systems can be referred to as a “*general reference monitoring network*”.

In a later stage of groundwater development, a reference monitoring network may be further upgraded to a “primary network”, which is a dedicated tool for overall observation of regional groundwater bodies. At that stage the groundwater potential becomes sufficiently well known and when the economic returns of monitoring become more obvious, more investments are justified to increase the level of detail. Primary monitoring networks may be combined with local “secondary networks” designed for specific needs or local detail. At that stage, the components of the monitoring programme (selected parameter sets, the network of monitoring wells and the frequency of observation) can be optimally adjusted to specific tasks, using detailed knowledge of the hydrologic and geochemical processes as well as sophisticated statistical techniques.

### 1.3 Focus and scope of the guideline

This guideline focuses on development of a “general reference monitoring programme” for the early stage of groundwater reconnaissance, groundwater development and groundwater management, as indicated in Table 1.1. The objectives of the monitoring programme are to supply data for characterisation of the regional groundwater systems, identification of trends in time and prediction of the regional impacts of groundwater abstraction. Technical as well as institutional and budgetary aspects will be discussed.



Table 1.1: Focus and scope of the guideline

Stages of groundwater resources assessment and development	Objectives of groundwater monitoring programme	Scale of groundwater monitoring	
		Regional scale groundwater monitoring	Local scale, specific groundwater monitoring
Reconnaissance of the groundwater system	<ul style="list-style-type: none"> <li>• Characterise the groundwater system (quantity and quality)</li> <li>• Estimate potential for groundwater development</li> </ul>	Existing observation points	Local scale monitoring may exist
Early stage of groundwater exploration and development	<ul style="list-style-type: none"> <li>• Identify trends in time in groundwater storage</li> <li>• Identify trends in time in groundwater quality</li> <li>• Study and predict regional impacts of groundwater abstraction</li> </ul>	Improved regional monitoring network, referred to as “general reference network”	Local scale monitoring may exist
Stage of intensive groundwater exploitation and management	<ul style="list-style-type: none"> <li>• Quantify impacts of groundwater abstraction (quantity and quality)</li> <li>• Determine state of contamination and remedial measures</li> <li>• Determine impact of groundwater management measures</li> </ul>	Optimised regional monitoring network, referred to as “primary network”, in combination with:	Specially designed problem oriented local or specific networks “secondary networks” e.g. for water supply and ecology

 Scope of the guideline. Focus points are described within this box.

*Limitations*

This guideline focuses on the characterisation and observation of regional scale groundwater systems, rather than on local scale systems. The procedures described result in a monitoring programme for general reference purposes. Regional scale monitoring programmes are incapable of providing the level of detail necessary to evaluate local scale scenarios such as the effects on groundwater levels of individual well fields, local contamination of a water supply, or the impacts of point sources of pollution caused by landfills or industrial sites. Additional local and specific monitoring networks will be needed to provide the information needed for management where such problems occur. Design of such types of networks is beyond the scope of this guideline.

## 1.4 General outline of the guideline

Figure 1.1 shows the general outline of the guideline, together with the chapters and annexes in which the different aspects and explanations can be found.

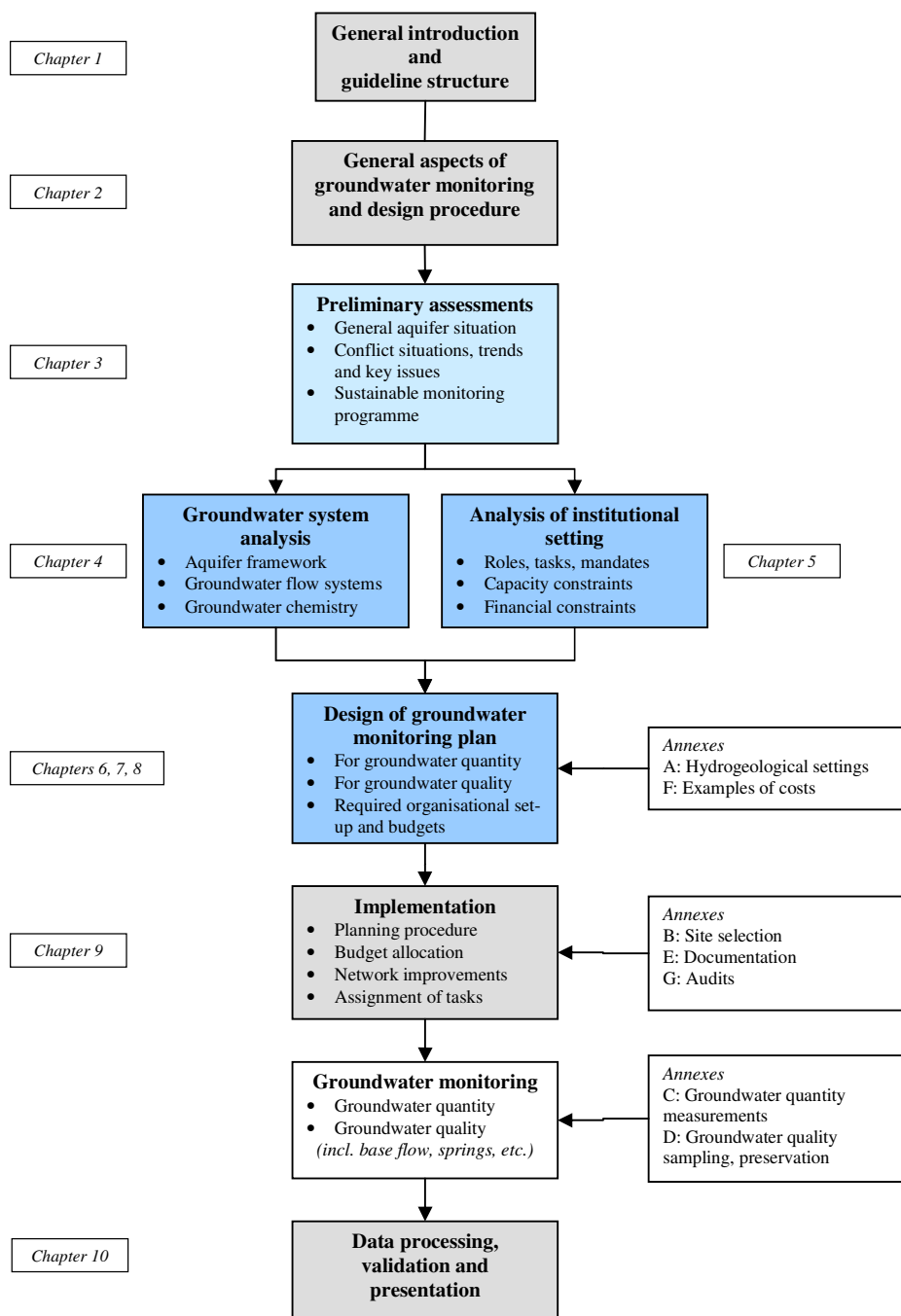

Figure 1.1: General outline of the guideline

The design procedure of this guideline consists of two phases. The first phase (in light blue) assesses the viability of the monitoring programme. This phase includes assessment of key technical issues and availability of financial resources for implementation of the monitoring programme. If the monitoring program is viable, the second phase (in dark blue) guides the user in further analysis and shows how a groundwater monitoring programme can be designed in balance with the data requirements and available financial and personnel resources. The guideline also addresses institutional aspects and practical aspects of programme implementation, data storage, processing, validation and presentation.

***The chapters of the guideline address the following subjects:*** (see Figure 1.1)

- Chapter 1 describes the purpose, focus, scope and limitations of the guideline, and provides some information on IGRAC's motives behind this initiative. The chapter also provides the general outline of the guideline.
- Chapter 2 gives a general introduction to groundwater monitoring and shows a detailed scheme of steps for analysing the situation at hand and designing a proper monitoring programme. The chapter also recommends a modular set-up of the monitoring programme and shows how the properties of a network can be used to adjust the programme to the available means.
- Chapter 3, *Phase 1* of the actual design procedure, provides guidance in evaluating whether and where systematic groundwater monitoring is desirable. If monitoring is desirable, the chapter assists in gaining a preliminary understanding of the aquifer and groundwater conditions and in defining what the focus and key issues of the monitoring programme(s) could be, considering the given groundwater situation and the budgetary and organisational conditions.
- Chapters 4, 5, 6, 7 and 8 together form *Phase 2* of the design procedure of the monitoring programme. The chapters provide guidance in designing a groundwater monitoring programme fitted to its particular situation.
  - Chapter 4 describes the analysis of the groundwater system and the set-up of a conceptual model.
  - Chapter 5 shows how the institutional setting can be analysed with respect to groundwater monitoring.
  - Chapters 6 and 7 discuss the approaches of designing a programme for groundwater quantity and groundwater quality monitoring respectively.
  - Chapter 8 focuses on preparation of the data necessary for selecting the most appropriate monitoring programme.
- Chapter 9 describes the process of implementation of a groundwater monitoring programme for general reference purposes. Design and implementation of a monitoring programme require good planning, clear agreements, sufficient communication to ensure support from stakeholders, timely procurement of budgets, manpower, etc.
- Chapter 10 discusses data management, covering data storage, processing, presentation and data validation. Data management is especially important as a follow-up of systematic groundwater monitoring. It improves access to the data, possibilities of data exchange, uniformity in storage and processing, and integrity of the data.

***The annexes of the guideline:***

The annexes provide additional background and practical information with respect to the design and optimisation of the monitoring programme, cost calculation and operational aspects of site selection, measurements, sampling and preservation of samples.

## 1.5 International cooperation

The effort of developing the guidelines was funded through a generous grant to IGRAC from the Dutch inter-ministerial bureau 'Partners for Water'. A team of international professionals was assembled which enabled the incorporation of expertise from different disciplines and experience from a number of geographic areas (Table 1.2). The working group was active from September 2004 until July 2006.

Table 1.2: Working group members

<b>Name</b>	<b>Affiliation</b>	<b>Country</b>
Premadasa Attanayake	Bechtel Corporation	USA
John Chilton	British Geological Survey (BGS)	United Kingdom
Gerrit Jousma	International Groundwater Resources Assessment Centre (IGRAC)	Netherlands
Armin Margane	Federal Institute for Geosciences and Natural Resources (BGR)	Germany
Carlos Martínez Navarrete	Instituto Geológico y Minero de España (IGME)	Spain
Maria Teresa Melo	University of Aveiro	Portugal
Pedro Nieto López Guerrero	Instituto Geológico y Minero de España (IGME)	Spain
Maurizio Polemio	CNR-IRPI (National Research Council)	Italy
Frans Roelofsen	International Groundwater Resources Assessment Centre (IGRAC)	Netherlands
S.K.Sharma	Geological Research Institute, Dehradun	India
Mike Streetly	ESI, Environmental Simulations International	United Kingdom
Ali Subah	Ministry of Water and Irrigation	Jordan
Ahmed Al Yaqoubi	Palestinian Water Authority (PWA)	Palestine/Gaza

## 2 Groundwater monitoring – general aspects and design procedure

***This chapter:***

*The purpose of this chapter is to provide a general introduction to groundwater monitoring and to propose a procedure for design and evaluation of a general reference groundwater monitoring programme.*

- *The subject of groundwater monitoring is described in the broader context of water management and international developments;*
- *The proposed design procedure comprises practical evaluation and design steps, each of them linked to a chapter (or chapters) with detailed description;*
- *Recommendations are given on how to set up a transparent multi-purpose monitoring programme that guarantees flexibility and efficiency;*
- *It is shown how the basic characteristics of a monitoring programme can be used as options to effectively tailor the monitoring programme to the needs and the available means.*

### 2.1 Groundwater monitoring – concepts and general aspects

***Groundwater assessment and monitoring***

*Groundwater assessment* is the evaluation of the physical, chemical and biological status of groundwater in relation to natural conditions and human interference. The assessment and monitoring process comprises a series of linked steps, as shown in Figure 2.1.

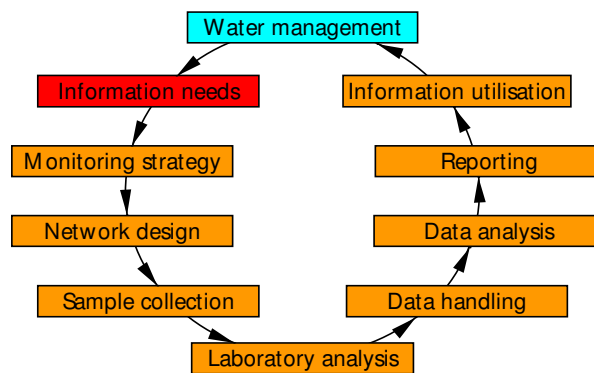

*Figure 2.1: The water quality assessment cycle (after Timmerman, 2000)*

*Groundwater monitoring* can be defined as the scientifically-designed, continuing measurement and observation of the groundwater situation. It should also include evaluation and reporting procedures. Within a monitoring programme, data on groundwater are to be collected as far as possible at set locations and regular time intervals. Although the legal basis, institutional framework and funding situation will impose their own objectives and constraints, still the underlying scientific or technical objective is to describe the groundwater situation in space and time.

The requirement for continuity and stability in the monitoring programme emphasizes:

- the need for long-term planning and commitment of staff and budgets;
- the need to understand the hydrogeological and hydrological setting

- the need to ensure uninterrupted access to sampling points.

The monitoring programme forms a key component of the assessment process, and is represented by all of the boxes except the uppermost three. The cycle also applies to groundwater quantity monitoring if the boxes “Sample collection” and “Laboratory analysis” are replaced by a single box: “Groundwater measurements”. The consecutive activities in the monitoring part of this cycle should be specified and designed according to the information needs and requirements of adjacent steps in the cycle.

***Defining the area to be monitored***

As a general principle, the area to be monitored should be defined on hydrological or hydrogeological criteria rather than political ones. Even if political or administrative boundaries determine institutional responsibility for monitoring, the interpretation and assessment should be made on the basis of physical units. That this is the basis for management is increasingly recognized by legislation such as the EU Water Framework Directive. The river basin, groundwater flow system or aquifer should always be the scale for which monitoring programmes are designed. This provides the basis for an integrated hydrological approach, in which surface water and groundwater and their interactions, and their potential links to estuarine and coastal environments are all considered together. An understanding of the hydrological and hydrogeological pathways and interactions at basin and sub-basin scales is therefore needed for establishing a monitoring programme. Use of the basin scale also allows the full scope of human, social and economic activities and their relationships to be assessed.

Using the river basin scale enables the assessment process to focus on management and the associated information needs. Thus, if by observing water quality at the outlet of the basin or flow system it is clear that the overall quality is getting worse, it is necessary to know what is causing this deterioration and where the cause is located within the basin. A more detailed scale of monitoring and assessment will be needed to identify in which sub-basin the problems are located, and whether the hydrological pathways are via surface water or groundwater (see Chapter 7).

***Defining information needs***

An early step in the preliminary stages of planning and implementation of a monitoring programme is to define the information needed as a basis for managing the quantity and quality of groundwater. This means deciding who (from a broad range of potential stakeholders) wishes or requires to be informed about groundwater, what types of information they need and for what purposes. It also requires consideration of the issue of what format they might require the information to be provided in to meet their various purposes, and how accurate and quickly the different stakeholders require the information. Information needs must be specified in sufficient detail so that design criteria for the monitoring and assessment system can be derived.

*Table 2.1: Essential questions concerning information needs*

<b>Information needs - questions</b>	<b>Illustrative examples of answers</b>
Who wants to be informed?	Governments, environmental regulators, water users, health authorities, the public, international agencies (EU, EEA, UNEP)
What types of information?	Groundwater level and quality status and trends, ancillary data for interpretation, DPSIR framework
For what purpose?	Reconnaissance, regulation, compliance, effectiveness of measures, public information
How accurate?	Time and spatial scale of observations, data aggregation, analytical results
How fast?	Weekly/monthly control, periodic reports
In what format?	Reports, maps, internet

These questions should be asked and answered as well as they can be early in the design of a new monitoring programme or, as may more likely be the case, when evaluating an existing programme with a view to improving it, recognising that information needs are unlikely to remain completely unchanged with time.

***Defining monitoring objectives***

In order to be effective, the groundwater monitoring programme needs to be adjusted to the data needs of data-users. Users may be governmental institutions, universities or private companies with tasks in the groundwater sector or related areas. The data are needed to investigate the actual groundwater situation, to plan groundwater development and to observe the effects of management measures. For design, implementation or evaluation of a monitoring programme, it will be necessary to have a good overview of relevant users, their goals and related data needs.

The data needs may be very diverse. Therefore it will be necessary to specify the objectives to be met by the monitoring programme. These “*groundwater monitoring objectives*” should be clearly specified in a written report by the groundwater experts in consultation with the groundwater managers and the users for which the monitoring programme is intended. Table 2.2 gives some examples of groundwater monitoring objectives:

*Table 2.2: Examples of groundwater monitoring objectives*

<p><i>Related to groundwater status and development:</i></p> <ul style="list-style-type: none"> <li>• Provide groundwater data for (sustainable) development of the groundwater resources;</li> <li>• Provide data for determining the best locations for groundwater abstraction;</li> <li>• Provide periodical information on the actual status of groundwater for management or for publication;</li> </ul> <p><i>Related to protection of groundwater systems and the environment:</i></p> <ul style="list-style-type: none"> <li>• Provide data for protection of groundwater systems from over-exploitation;</li> <li>• Provide data for protection of nature conservation areas from unacceptably declining groundwater tables;</li> <li>• Provide data for control of saline water intrusion or up-coning in aquifers;</li> <li>• Provide data for control of land subsidence caused by groundwater abstraction;</li> <li>• Provide data for protection of aquifers from contamination by diffuse sources of pollution.</li> </ul>
--

Apart from technical aspects related to the above objectives, also operational aspects or management practice may have influence on the monitoring programme and the presentation of data. For instance, the time cycle of river basin plans may require a simultaneous cycle of monitoring and reporting. Another example comprises the data requirements related to operational and surveillance monitoring under the (European) Water Framework Directive (EU, 2000). Such management requirements may influence the frequency and time of observation, as well as the frequency and form of presentation of the data (specific maps, graphs, statistical parameters, etc.).

Finally, the selected monitoring objectives and specific data needs will have to be reworked (translated) into the properties of the monitoring programme (set-up and density of the network, selection of parameter sets and frequency of observation).

***Data source types involved***

Different sources of data can be used to support the above management objectives. Table 2.3 shows the different types of sources of groundwater data used to meet the management objectives shown in Table 2.2. The relative importance of the data sources for the different management objectives is given by (x) for desirable data and (xx) for necessary data.

Table 2.3: Example of data needs from different data sources for specified objectives

Monitoring objectives	Groundwater observation wells			Groundwater pumping wells			Springs			Surface water observation points		
	levels	discharge	quality	level	discharge	quality	level	discharge	quality	level	base flow	quality
<i>Groundwater development</i>												
1	GW system characterisation	xx	n.a.				x			x		
2	GW potential for development (quantity and quality)	xx	n.a.	xx				xx	xx		xx	x
3	Best locations for well fields	xx		xx		xx			x			(x)
<i>Control and protection</i>												
4	Trends of over-exploitation	xx	n.a.	x	xx			xx			xx	
5	Nature conservation	xx	n.a.		xx		x	xx			xx	
6	Saline water intrusion	x	n.a.	xx*	x	xx	xx*			x	x	(x)
7	Land subsidence	x	n.a.		xx							
8	Contamination of aquifers		n.a.	xx		xx		xx				xx

x = desirable data; xx = necessary data; xx\* = mainly Chloride; n.a. = not applicable.

Translation of these data needs into the focus and properties of the monitoring programme is discussed in chapters 6 and 7.

### ***Making use of existing data***

The strategy for designing a monitoring and assessment programme should take adequate account of existing information. At an early stage inventories should bring together information that is available but often distributed between different agencies and institutions or their various departments. Inventories should cover the major aspects that are relevant to identification and analysis of issues. These include for example: water uses and water needs, groundwater levels, groundwater quality, land uses and non-point pollution sources from land use, such as fertilisers and pesticides. Water quality surveys are intended to give a first insight into the functioning of the aquatic ecosystem and the occurrence of pollution and its impacts on groundwater systems. The availability of existing groundwater level and quality records should also be taken into account when designing the monitoring network and selecting sites as maintaining long-term series is likely to be an important monitoring objective.

### ***Prioritizing monitoring efforts***

No monitoring programme can provide the data needed for all actual or potential issues related to groundwater management and protection. Low budgets will very often be a major limiting factor for groundwater monitoring. Also lack of institutional embedding, mandates, manpower, experience, etc. may stand in the way of very ambitious monitoring programmes. Differentiation of monitoring programmes and setting priorities will then be needed to achieve a sound balance between the value of data collected and the labour and costs involved in collecting them.

One way of setting priorities is by making use of risk assessment. Concerning groundwater quality, the long-established and widely adopted approach of defining and mapping the vulnerability of aquifers to pollution can be used to prioritize monitoring activities. Based on the physical and chemical properties of the soil and the geological materials above the water table, the potential for pollutants to be retarded and attenuated is evaluated and mapped. Where such maps exist, they can be



used to help focus monitoring to areas where groundwater has important uses and where it is most vulnerable.

Differentiation of the monitoring programme is also possible by reducing ambitions. This can be done in many different ways, for instance by monitoring pilot areas, selecting indicative points or by using a lower frequency of observation. A lower ambition level will often lead to a reduced level of information, but that level may still be acceptable for the users.

***Gradual approach.***

Design of a monitoring programme is a complex exercise that requires knowledge and experience. Even with sufficient knowledge and experience available, designing a monitoring programme will be an iterative process in which the final result will usually be reached after considering and weighing different options. If experience with groundwater monitoring is limited, it may be wise to develop the monitoring programme by starting with some practical unit. A gradual approach will provide insight in the labour and costs involved in the final design and realization of the monitoring programme.

***Presentation of results***

Investments in the monitoring programme will only be guaranteed if the data from the monitoring network meet the objectives and needs of the users. So, the data gathered and the information presented should be considered a major factor in convincing that continued support is necessary. Non-deliverance of the required information may be a reason for decreasing interest and investment, in the worst case leading to the complete elimination of the monitoring programme.

## 2.2 Proposed design procedure

The design of a groundwater monitoring programme involves a number of steps, as shown in the coloured components of Figure 2.2. These steps are intended to make sure that the programme provides optimal data to the users: institutions and persons involved in groundwater assessment, development, management and protection or other groundwater-data dependent activities.

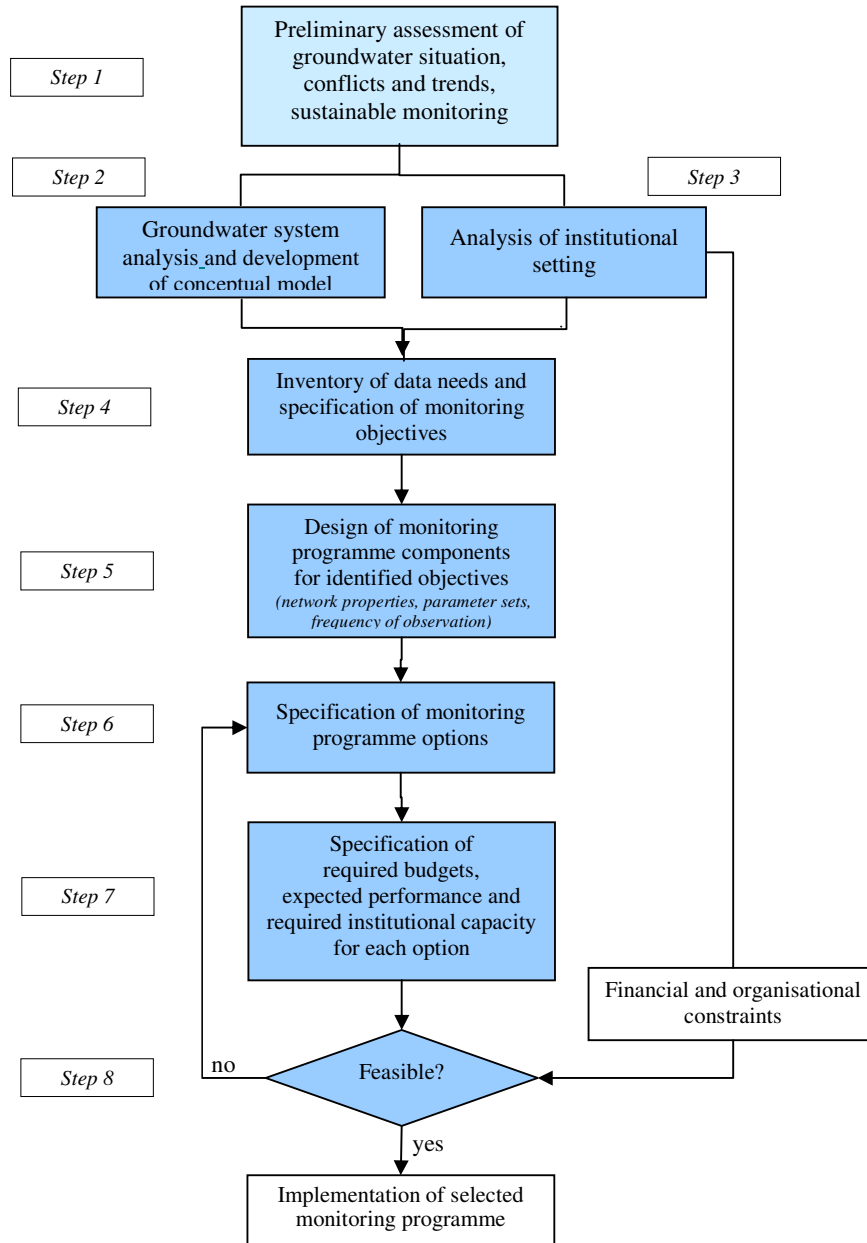

Figure 2.2: Scheme for design of a groundwater monitoring programme

The light coloured block represents Phase 1 of the monitoring design procedure, covering preliminary assessments (Chapter 3). The dark coloured steps correspond with Phase 2 of the design procedure, consisting of detailed investigations outlined in Chapters 4 through 8.

The proposed procedure for designing a groundwater monitoring programme (see Figure 2.2) involves the following steps:

- **Step 1: Preliminary assessment of the groundwater situation, the problems and trends as well as the size of a sustainable groundwater monitoring programme**  
 This step is to assist in evaluating whether or not systematic groundwater monitoring is desirable in an area and what the objectives and scope of the monitoring programme(s) should be, considering the given budgetary and organisational conditions. The activities described are aimed at providing the components for a “quick scan” of the groundwater situation, the actual problems and a list of key issues for monitoring.
- **Step 2: Analysis of the groundwater system and development of a conceptual model**  
 This step involves analysis of the groundwater system (aquifer and flow systems) and development of a conceptual model on the basis of available hydrogeological and hydrological information. The conceptual model, in turn, forms the technical framework for the groundwater monitoring network design. Groundwater quality is also analysed in relation to the groundwater flow systems defined.
- **Step 3: Analysis of the institutional setting**  
 This step concerns an inventory of the institutions involved in groundwater exploitation, management and protection as well as analysis of their roles, mandates, tasks and related budgets and manpower. Evaluating these conditions should lead to a better idea of the scope and limitations related to extending or improving groundwater monitoring.
- **Step 4: Inventory of data needs and specification of monitoring objectives**  
 The inventory of data needs includes listing the users of groundwater data and assessing their data needs. Monitoring objectives may include provision of data for assessment, development, use, management and protection of groundwater resources.
- **Step 5: Design of groundwater monitoring programme components for identified objectives**  
 This step concerns analysis of the monitoring objectives and translation into components of the monitoring programme. Each monitoring objective leads to a monitoring component with its own specific requirements (area to be covered, preferential network set-up, parameters needed, frequency of sampling, etc.). By bringing the components together in a scheme, the various functions and needs of the monitoring programme will become clear. Because of the complexity of situations, a modular structure of the monitoring programme is recommended.
- **Step 6: Specification of monitoring programme options**  
 Feasibility of a monitoring programme depends among other things on the budgets and institutional capacity available. It is good practice to consider a limited number of possible monitoring programme options, for instance with increasing level of complexity. Options may differ with respect to the scope of the programme, the area covered or the properties involved (e.g. network density, frequency of observation, etc.). Specification of the options to be considered should be done in consultation with representatives of the institution responsible for groundwater management and monitoring. The details of the programmes considered should be clearly specified in maps and/or tables.

- **Step 7: *Specification of required budget, expected performance and necessary institutional capacity for each option considered***  
 To prepare for the selection process, further analysis requires for each monitoring programme option considered:
  - a) Calculation of investments and annual costs involved in the monitoring programme;
  - b) Description of the information level expected (areas covered, objectives covered, estimated accuracy, etc. Also, strong points and limitations should be indicated;
  - c) Analysis of institutional capacity needed and of possible limitations.
  
- **Step 8: *Evaluation of feasibility and selection of best monitoring programme option***  
 This step includes evaluation of the feasibility of the monitoring programme options considered on the basis of the information resulting from step 7 and selection of the best monitoring programme option for implementation. New options may have to be specified (step 6) and analysed (step 7) if none of the programme options considered turns out to be feasible or sufficiently attractive.

### 2.3 Modular set-up of the groundwater monitoring programme

Measurement points, especially observation wells, can have different functions within the monitoring programme. Some points may have a single function (e.g. only water levels), while other points have multiple functions (e.g. water levels and water quality monitoring). Differentiation in the monitoring programme in conformity with the specified functions can be very cost-effective, especially in groundwater quality monitoring programmes. For instance a limited number of selected “indicative” points may be used for annual monitoring of trends while a larger number of points may be used for five-yearly reports on the spatial water quality distribution.

In order to enable flexible planning and control of a groundwater monitoring programme with respect to the role of the various observation points, the programme has to be transparent. When the priorities in groundwater management evolve, the focus of the monitoring programme will also change. Changes in the monitoring programme may lead to withdrawal of certain observation points that have lost their function, which saves costs. Also the sampling programme may change in time, depending on the evolution of information and priorities. From experience with complex monitoring programmes, it appears to be advantageous if the different functions of observation points are clearly linked to the various objectives and data requirements defined by groundwater management.

Figure 2.3 shows how the monitoring programme can be composed of different monitoring components, each linked to one of the groundwater management objectives and the data sets required.

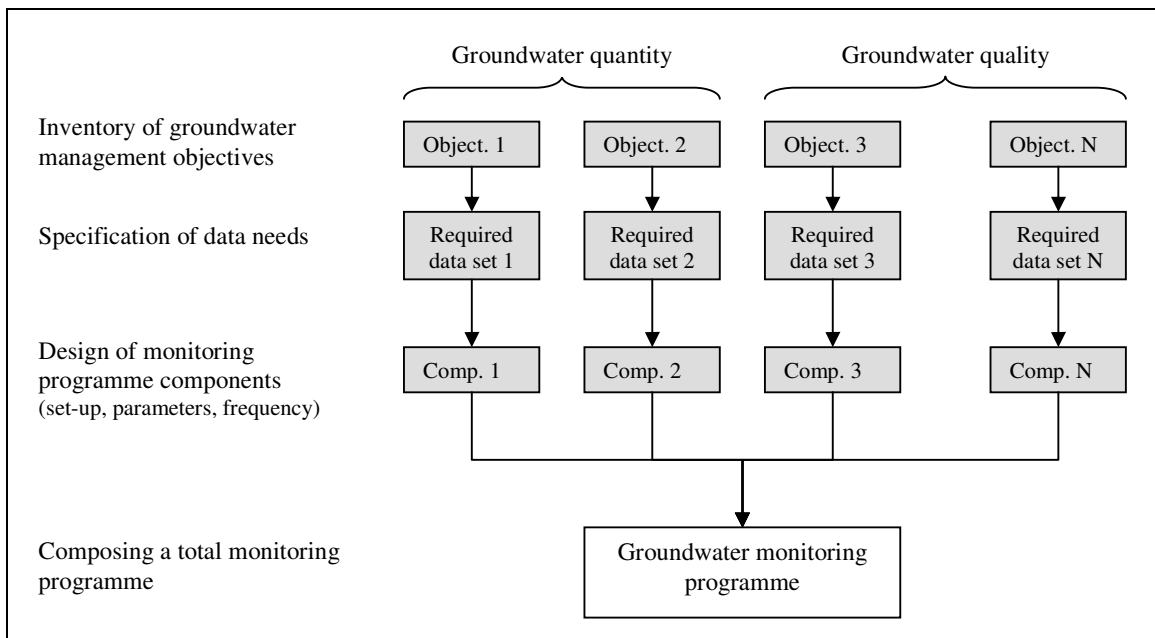

Figure 2.3: Modular set-up of a monitoring programme

The different components of the groundwater monitoring programme follow from the data needs related to groundwater development, management and protection in the region of interest. Several objectives may have to be served at the same time. For instance: a) determine the potential for groundwater development of the region, b) investigate whether the groundwater quality in vulnerable zones of that region shows the impacts of land use c) monitor the position of the fresh water/saline water interface in the coastal zone of that region. Such objectives and data needs make different demands on the monitoring programme, both in space and time.

For establishing a multifunctional groundwater monitoring programme it will be necessary to prepare maps showing the spatial distribution of groundwater monitoring objectives deduced from the needs for groundwater reconnaissance, development, use or protection. This may include mapping basic information such as land use to look for potential threats to groundwater quality. The various monitoring objectives will generally show spatial overlaps where monitoring points are needed with multiple roles. The maps will help to select the most suitable observation points for particular purposes. Selected and newly installed wells may serve different purposes at the same time.

## 2.4 Basic options of monitoring programmes

In addition to the monitoring objectives and the hydrogeological setting, the dynamic behaviour of the variables to be measured (groundwater levels, groundwater quality) is an essential factor in the design of monitoring programmes. The basic properties of the monitoring programme can be adjusted to the spatial and temporal ranges of these variables, provided that their expected means and fluctuation can be roughly estimated. Even if the behaviour of these variables is not yet known, reasonable estimates can often be made on the basis of a) local information and b) experience with hydrologic and chemical processes in other areas. In the following paragraphs some examples of different monitoring network set-ups are discussed.

### ***Use of regional networks versus local networks***

The choice of a monitoring network depends very much on the variability of the data to be observed. If the spatial variability of a measured parameter or variable is high (significant correlation between the records of observation points only exists over short distances) monitoring points will only yield locally representative values. Examples of such locally representative variables are: soil moisture values in the unsaturated zone, groundwater table values in karstic aquifers or nitrate concentrations in villages of rural areas. If, on the contrary, the spatial variability of data is low monitoring points can be representative for a larger area of the observed data. An example is groundwater levels in a confined aquifer.

*Dense local networks.* As a general rule producing a reliable spatial image of locally representative parameters requires closely spaced monitoring points. Collection of such locally representative data from a widely-spaced network can only be considered as random samples from a large population, which may not produce a representative picture. So, even statistically a widely spaced network may not produce the desired results. If locally representative phenomena with a high degree of variability need to be studied, for instance in support of groundwater policy, a *specially designed local network with sufficient density* is the best option.

If the investigations are intended to cover a larger region then *selected pilot areas* with such specially designed local networks will probably provide sufficient information. That solution will be much more practical and cost effective than a regional network with a high density.

*Widely spaced regional networks* should be reserved for monitoring variables or parameters representative for relatively large areas (e.g. water levels in confined or semi-confined aquifers). The wide spaced network will provide a more or less continued spatial impression of the variable or parameter studied. Another way of using a widely spaced regional network is for determining a parameter that is statistically representative for the area (e.g. a parameter representative for the degree of groundwater contamination from non-point sources). In such case the data need to be collected through a *sample survey* from locations having comparable hydrogeological conditions. The locations sampled may be isolated from one another but their number needs to be sufficient for the statistical analysis. This method is frequently used in studies of groundwater quality, for instance for determining the degree of groundwater pollution in areas with different types of land use and soils.

### ***Use of distributed networks versus indicative monitoring points***

*Distributed monitoring networks.* Distributed monitoring networks are the usual form of groundwater monitoring networks. The required distribution of monitoring points in a regional network is a function of the parameters to be monitored (defined by the monitoring objectives) and the conditions that are responsible for the spatial image of these parameters. Relevant conditions may be altitude, hydrogeological setting, surface water drainage, land use type, soil characteristics, etc. It is important that conditions relevant for spatial variation of the parameter studied be represented in the set-up of the monitoring network.

Networks for groundwater level monitoring may be attuned to dominant hydrogeological conditions in the area, for instance by assigning a different network density to zones with unconfined and confined aquifers. Regional differences in groundwater quality may be the result of a more complex set of conditions, such as land use type, hydrological conditions (zones of recharge and discharge) and soil properties. Since detailed data on these conditions are not always available, only the available information can be used as a basis for network design.

*Indicative monitoring points.* For the purpose of this guideline the term “indicative” monitoring point has been introduced. An indicative monitoring point should be representative for the response of a part of the regional groundwater system or the system as a whole to the stresses upon it. Examples of

such regional phenomena are the drawdown of the water table caused by distributed groundwater wells or contamination of the groundwater system by non-point sources of pollution.

An indicative point should be a “thermometer” of the groundwater system under stress. Its record should be indicative for the overall behaviour of the system, so that groundwater managers receive characteristic information on the actual status of the system and are alerted to possible trends. This information will make it easier to start planning further development or interference if the system is in danger. For further development of large groundwater systems, indicative monitoring points will not be sufficient. For that purpose a more solid distributed network will usually be needed.

*At an early level of network development, indicative observation wells are very valuable. As networks grow the density usually increases towards a more distributed network.*

### ***Use of 2-dimensional set-up versus 3-dimensional set-up***

In many cases the groundwater conditions are essentially 3-dimensional and in developing a groundwater monitoring programme this dimensionality needs to be adequately considered. In some cases, however, a predominantly 2-dimensional setting does exist, for example in rather straight sections of coastal areas, in extended river valleys, near geological faults, etc. It is essential that the hydrogeological profile and the groundwater levels show a minimum to zero variation in one direction. The groundwater levels can then be monitored in a direction perpendicular to the first one, e.g. in coastal zones perpendicular to the coast. The monitoring network can exist of some rows of monitoring points in the direction perpendicular to the main axis. The distance between these rows depends on the minor variation in the direction of the main axis. This network of rows of monitoring points is much less expensive than a full 3-dimensional monitoring network, while it may guarantee the same accuracy.

### 3 Groundwater problem identification and preliminary assessments

***This chapter:***

*This chapter describes the first phase of the design procedure. The purpose of the chapter is to assist in evaluating whether or not systematic groundwater monitoring is desirable in a certain target area and, if that is the case, in defining what the objectives and scope of the monitoring programme(s) might be, considering the given groundwater situation and the budgetary and organisational conditions. The chapter describes:*

- *Preliminary assessment of the presence or absence of aquifer systems in the target area and the possible need for groundwater monitoring. Division of the area into aquifer and non-aquifer zones;*
- *Preliminary assessment of the groundwater situation, the (potential) conflict situations and the observed trends per groundwater zone. The potential conflict situations and observed trends lead to key issues for the groundwater monitoring programme. Priorities may be given with the help of scores.*
- *Preliminary assessment of the scope of the monitoring programme that can be sustained with given budgets and institutional capacity. Also the design activity should be in balance with the scale of the sustainable programme.*

*It may be stressed that the tables and scores presented in this chapter are examples that may be used, altered or disregarded depending on the needs.*

#### 3.1 Purpose and approach

The purpose of this chapter is to assist in evaluating whether and where systematic groundwater monitoring is desirable and, if that is the case, in defining what the objectives and scope of the monitoring programme(s) might be, considering the given groundwater situation and the budgetary and organisational conditions.

An inventory of the data needs for development, management and control of groundwater resources may lead to a large range of monitoring objectives that ideally should be met by the monitoring programme. However, under limitations of financial resources and institutional capacity, monitoring will have to be in balance with the capacity and budgets available. This means that priorities will have to be set with respect to the goals that can be pursued in the actual stage of monitoring. In a similar way there should be a balance between the investment in design of the monitoring programme (personnel and material costs) and the scope of the monitoring programme expected. This chapter addresses:

- A quick scan of the problem situation and preliminary definition of the key issues for the monitoring programme (sections 3.2 through 3.5);
- A preliminary assessment of the size of a sustainable monitoring network that can be sustained with budgets and capacity available (section 3.6).

***A quick scan of the groundwater situation and specification of key issues***

Phase 1 of the guideline includes a quick scan of the groundwater situation in the target area, its users and dependent functions. An evaluation of conflict situations should result in a listing of key issues to



be addressed by the monitoring programme. The outcome of this first phase will assist in planning and prioritising further investigations and ascertain that budgets are spent on investigating the right items in a more effective way. It can be used to direct further investigations and will alert managers to possible bottlenecks.

If the groundwater situation and its problems are already known very well and if the assignment to design and/or evaluate a monitoring programme is already very clearly defined, this part may be skipped. However, if the groundwater situation and related problems are not yet clear, this chapter may assist in analysing the situation (both technical and institutional aspects), create a better awareness of the problem complexity and help in defining the right focus and feasible scope of monitoring activities. If the desired scope of a monitoring programme exceeds by far the budget and manpower available, managers need to be warned regarding the impossibility to fulfil their demands.

### ***Defining a sustainable scale of monitoring***

One of the initial checks to be performed is to define to what extent a monitoring programme resulting from the monitoring design project can be developed and sustained within the available budgetary and institutional capacity. The costs of establishing and maintaining a monitoring network and sustaining a monitoring programme should not be underestimated. Tables showing the different types of costs have been included in chapter 8 and annex F. For a quick scan of the scale of monitoring programme that can be sustained it is necessary to have a fair idea of the budget and capacity available, and the unit costs involved in different parts of a monitoring programme (Section 3.6).

### ***Remarks***

It should be stressed that the tables and scores presented in this chapter are suggested examples that may be used, altered or disregarded, depending on the needs. The results may be used as the basis for an “inception report” that describes the terms of reference for the design phase of the groundwater monitoring programme needed.

## **3.2 Preliminary characterisation of the area**

### ***General characteristics of the target area***

General characteristics of the area that are essential for further evaluation have been listed in Table 3.1. These include:

- Location and size of the area and its boundaries with other areas or the sea;
- Climate of the area, possibly divided into different zones;
- Hydrographical characteristics. The area considered may be part of one catchment or have overlap with several ones.
- Topography: division into mountainous, hilly or plain zones. These topographical characteristics are often related to the geology of the area.

The position of the area near to or away from the sea is important for potential problems of salinisation and land subsidence. Besides being an essential factor in the geological evolution of the area, its nature and inhabitants, climate is a determining factor in recharge of groundwater bodies and in losses through evapotranspiration. Catchment boundaries are important for groundwater systems when considering the balance between recharge and discharge and the potential for development of the groundwater systems. Prominent catchment divides, such as mountain ridges, may fully isolate or divide groundwater bodies. Also in shallow aquifer systems groundwater divides often correspond with the catchment divides. However, in deep aquifer systems there may be no clear relation between

the catchment boundary and the groundwater divide and the boundary conditions need to be considered carefully.

Surface elevation is a major factor in creating and sustaining natural groundwater flow systems and dependent vegetation, if the geology allows for it (chapter 4). Even relatively small differences may have a significant influence on the dependency of vegetation. For instance, vegetation in river beds or on a valley floor may depend greatly on groundwater, while vegetation on topographical heights with a deep groundwater table depends on rainfall only. This has consequences for the role of a groundwater monitoring programme as well.

Table 3.1: General description of the area considered

General characteristic	Answer	Type of answer
Size and location:		
• Size of area		(km <sup>2</sup> )
• Completely inland		Yes/no
• Area with coastal zones		Yes/no
• Length of coastal zone		(km)
Climate:		
• Humid		% of total area
• Semi-arid		% of total area
• Arid		% of total area
River basin characteristics:		
• Target area part of one large river basin		Yes/no
• Target area overlapping several unconnected river basins		Yes/no
Topography:		
• Mountainous areas (steep slopes, only narrow valleys)		% of total area
• Hilly/undulating areas (wide valleys, smooth crests)		% of total area
• Plain to slightly sloping areas (including large valleys)		% of total area

In conclusion, maps of surface elevation and surface water systems constitute indispensable information for assessment of the groundwater flow system(s) and for design of the groundwater monitoring programme as well. A map of climate zones is needed for calculation of recharge and losses through evapotranspiration.

### 3.3 Preliminary characterisation of the aquifers

#### *Hydrogeological characteristics of the area*

The geology of an area determines the “hydrogeological framework” of aquifers, aquitards and aquicludes, which houses the groundwater bodies. The hydraulic characteristics of the framework determine whether significant volumes of groundwater can be stored or just thin and isolated groundwater bodies occur. The chemical composition of the formations is a determining factor in the groundwater quality. Storage and quality of the groundwater determine the perspectives of groundwater development and indirectly the need for a monitoring network.

Based on worldwide conditions two situations can be distinguished:

- Situation A: A hydrogeological map of the area is available;
- Situation B: Only geological information is available.

*Situation A: A hydrogeological map of the area is available.*

If a hydrogeological map of the area is available that map can be used for a further division of the area, for instance into “aquifer environment” and “non-aquifer environment” according to the UNESCO classification (Table 3.2).

*Table 3.2: Aquifer zones and non-aquifer zones in the area*

Hydrogeology	Answer	Type of answer
Aquifer environment	• Regional porous aquifers	% of total area
	• Regional fissured aquifers	% of total area
Non-aquifer environment	• Regions with only local aquifers	% of total area
	• Regions without significant aquifer rocks	% of total area

Based on the hydrogeological map, the areas having aquifers and remaining areas should be indicated. The size of the areas is a first indication regarding the possibilities of groundwater development.

*Situation B: Only geological information is available*

If a hydrogeological map of the area is not yet available the aquifer and non-aquifer areas will have to be determined on the basis of geological maps. The following classification Table 3.3 may then be used.

*Table 3.3: Geology of the area*

Geology	Answer	Type of answer
• Unconsolidated deposits		% of total area
• Consolidated sedimentary basins		% of total area
• Volcanic terrains		% of total area
• Basement complex and major intrusives		% of total area

Based on the geological map the areas with potential aquifers and the remaining areas may be shown on a draft hydrogeological map. The size of the potential aquifer areas is a first indication regarding possibilities of groundwater development.

*Warning: If the target area or a large part of it consists of “non-aquifer environment” and if only local patches of shallow aquifer occur, for instance in weathered zones of Basement terrains, then substantial and systematic groundwater monitoring will not be required. Further investigations for design of a monitoring programme may then be stopped.*

***Division of the target area into zones***

If the groundwater situation in the target area is complex, e.g. comprising different aquifer and non-aquifer zones, divided over several (sub-)catchments and exhibiting differences in land use, it may be useful to divide the area into practical zones (for instance a total between 5 and 20). A sub-division according to (sub-)catchments is especially relevant if the groundwater systems may have a direct interaction with the surface water system, e.g. when the groundwater table is relatively close to the land surface in plains or alluvial fills. If the groundwater table is deep and out of direct reach of surface water, sub-division according to sub-catchments will often not be necessary.

For further analysis of the status of the groundwater system(s), its (their) potential for development and the need for a monitoring programme, a combined map may be constructed. The map should show:

- different topographic zones (e.g. divided into mountains, hilly area, plains)
- different catchments and sub-catchments, based on topography and drainage pattern (rivers, streams, lakes, sea)

- the aquifer and non-aquifer zones of the area, based on (hydro)geologic information.

For shallow aquifers a division into zones may be based on the topography and (sub)-catchment boundaries. Further sub-division may be made on the basis of land-use for instance.

For deep aquifers a division may be based on major groundwater systems for instance.

**Characteristics of aquifer system per zone**

Preliminary estimates of the aquifer system’s characteristics collected in Table 3.4 may provide the following information:

- Extent and saturated thickness and estimated porosity may help in determining in which areas or zones groundwater bodies are significant in terms of total volume stored.
- The type of confinement shows where the groundwater body in the upper aquifer is totally unprotected or relatively well protected from pollution sources at the surface.
- The depth to water is important to decide whether the groundwater body is generally interacting with the surface water or disconnected from it.

Table 3.4: Characteristics of aquifer system per zone

Zone	Aquifer system characteristics – preliminary estimates					
	Type:	Confinement upper layer	Lateral extent (km <sup>2</sup> )	Total thickness (m)	Depth to water (m)	Total stored volume (million m <sup>3</sup> )
Zone 1						
Zone 2						
Zone 3						
.....						
Zone N						

*Type of answers*

Type:	Single layer (SL)	Multi layer (ML)	
Confinement (upper layer) :	Unconfined (U)	(Semi)-Confined (C)	(% U / % C)
Lateral extent (km <sup>2</sup> )			
Estimated total thickness:	< 20 m	20 – 50 m	> 50 m
Estimated depth to water:	< 5 m	5 – 50 m	> 50 m
Total stored volume (million m <sup>3</sup> )			

### 3.4 Preliminary assessment of the groundwater situation

**Groundwater situation – preliminary estimates**

Table 3.5 may be used to provide a preliminary overview of the recharge and storage of groundwater per zone as well as the percentage already abstracted.

- The estimated direct and indirect recharge provides a very rough upper limit of the annual volume of groundwater available for natural discharge and abstraction.
- The percentage of recharge being used for abstraction should give a rough indication of which zones are under stress of abstraction and which zones are relatively free from stress.
- The relation between abstracted annual volume and the average stored volume of groundwater shows whether the buffer capacity is sufficient for dry periods.
- In arid and semi-arid zones the stored volumes in large and thick aquifer systems are sometimes used for water supply, thus slowly depleting the aquifer system (e.g. in the Libyan region).

On the basis of such preliminary estimates, groundwater outflow and natural discharge will be unknown or very uncertain quantities. Consequently the annual volumes remaining for further development will require more detailed investigation.

**Table 3.5: Groundwater quantity situation - preliminary estimates**

Zone	Estimated recharge groundwater body			Total stored volume (from Table 3.4) (million m <sup>3</sup> )	Groundwater quality for water supply	Total abstraction divided by total recharge (%)
	Estimated direct recharge from rainfall (million m <sup>3</sup> /year)	Estimated indirect <sup>1</sup> recharge from rivers/canals (million m <sup>3</sup> /year)	Total estimated recharge (million m <sup>3</sup> /year)			
1						
2						
3						
N						

<i>Type of answers:</i>			
Groundwater quality for water supply	Suited	Restricted use	Not suited
Total abstraction divided by total recharge (in %) (either calculated percent. or classified as follows:)	< 25%	25 - 50 %	50 - 75 % >75 %

Note<sup>1</sup>: In some situations, indirect recharge may also come from irrigated land and in large urban areas from leaking water mains, leaking sewers and from disposal of storm drainage. The presence of these possible recharge sources should be noted for more detailed investigation (chapter 4).

### ***Conflict situations with respect to groundwater quantity***

The general reference monitoring network will have to reliably depict the groundwater situation on a regional scale (Chapter 1). That function covers the natural situation as well as the regional impacts of groundwater use and surface water management.

#### *Potential conflict situations with respect to groundwater quantity.*

Table 3.6 may be used to indicate what types of groundwater abstraction, groundwater dependent functions and processes may occur in the zones considered. Conflicts may occur when different user groups compete for the groundwater available in a zone, or when functions or processes that depend on the groundwater level suffer from strong abstraction, for instance. The table may be completed with the scores given in the legend, or any other type of scores considered more suitable. The proposed scores are simple qualitative ratings, ranging from “none” to “very important”. In the case of wells this might be expressed in estimated numbers as well. The table and scores may be changed according to the needs and information available.

**Table 3.6: Potential conflict situations - groundwater quantity**

Zone	Surface water	Groundwater supply		Groundwater dependent functions			Groundwater dependent processes	
	Surface water measures influencing groundwater	Public water supply from tube wells	Irrigation from groundwater wells	Urban water supply from open wells	Groundwater fed springs and streams	Groundwater dependent Eco-system	Salinisation/saline intrusion	Land subsidence
1								
2								
3								
N								

<b>Legend:</b>	<b>importance</b>	<b>numbers</b>	<b>strength</b>
-	no	none	no
+	little	few	weak
++	medium	some	medium
+++	much	many	strong

The results of Table 3.6 will be analysed in Section 3.6.

*Observed trends in groundwater quantity*

Table 3.7 may be used to trace which negative impacts in the area are already known. This can be done on the basis of information available from the area or by inquiring from well owners, water managers, officials, etc., who are aware of the situation in the area.

The following categories of trends have been distinguished:

- Observed increase of surface water management measures affecting groundwater;
- Observed increase of water supply from groundwater;
- Observed increase of problems with groundwater dependent functions;
- Observed increase of groundwater dependent processes.

Urban water supply from open wells (minor use) may be classified as a vulnerable function, because the wells have to be deepened or abandoned when the groundwater level drops too much. If at the same time some of the open wells provide water for irrigation schemes, which may take considerable quantities of water, that activity should be classified in the column "Irrigation from groundwater wells". An observed increase of problems with groundwater dependent functions occurs when groundwater levels are falling. Groundwater dependent processes such as salinisation and land subsidence usually increase when groundwater levels decline.

*Table 3.7: Observed trends – groundwater quantity*

Zone	Observed increase of measures	Observed increase of groundwater abstraction		Observed increase of problems for groundwater dependent functions			Observed increase of groundwater dependent processes	
	Surface water affecting groundwater	Public water supply from tube wells	Irrigation from groundwater wells	Urban water supply from open wells	Groundwater fed springs and streams	Groundwater dependent Eco-systems	Salinisation/ saline intrusion	Land subsidence
1								
2								
3								
N								

Legend:	importance	numbers	strength
-	no	none	no
+	little	few	weak
++	medium	some	medium
+++	much	many	strong

**Conflict situations with respect to groundwater quality**

*Potential conflict situations with respect to groundwater quality*

Table 3.8 may be used to indicate which threats to groundwater quality and which groundwater dependent functions occur in a zone. Natural contaminants and saline groundwater may pollute large parts of aquifers when they are drawn in by groundwater abstraction. Also diffuse pollution from agriculture or large urban areas may endanger groundwater quality in the aquifers. Where large urban areas are also heavily industrialised, it is worth noting this in the preliminary assessment for more detailed investigation later. Although considered individually as point sources, uncontrolled multiple discharges of untreated effluents from large numbers of small industries can become a source of diffuse pollution to shallow aquifers in urban areas. Groundwater dependent functions or processes may suffer from increased pollution.

The table may be completed with the scores given in the legend or other suitable scores. The proposed scores are simple qualitative ratings, ranging from “none” to “very important” or equivalent indications. The table and scores may be changed according to the needs and information available.

Table 3.8: Potential conflict situations - groundwater quality

Zone	Threats to groundwater quality				Groundwater dependent functions			
	Natural contaminants (F, As)	Salinisation	Intensive agriculture	Urbanisation	Water supply from tube wells	Water supply from open wells	Springs or streams	Ecosystems
1								
2								
3								
N								

Legend:	importance	strength	numbers
-	no	no	none
+	little	weak	few
++	medium	medium	some
+++	much	strong	many

*Observed trends in groundwater quality*

Table 3.9 may be used to indicate whether deterioration of groundwater quality is already a fact in particular zones of the area. This can be done on the basis of information available from the area or by inquiring from well owners, water managers, officials, and other persons who are aware of the situation in the area.

The following categories of trends have been distinguished:

- Observed increase of groundwater pollution caused by diffuse sources of pollution; (Local sources of pollution have not been considered as the regional scale groundwater reference monitoring network is not suited to monitor them).
- Observed increase of pollutants in groundwater abstracted for water supply;
- Observed increase of groundwater quality problems for groundwater dependent functions (springs streams or ecosystems);

Table 3.9: Observed trends – groundwater quality

Zone	Observed increase of groundwater pollution caused by diffuse sources				Observed increase of groundwater quality problems for groundwater dependent functions			
	Natural contaminant (F, As)	Salinisation	Intensive agriculture	Urbanisation	Water supply from tube wells	Water supply from open wells	Springs or streams	Ecosystems
1								
2								
3								
N								

Legend:	strength
-	no
+	weak
++	medium
+++	strong

A preliminary evaluation of the conflict situations is given in section 3.5.



### 3.5 Preliminary evaluation of results and specification of key issues

Preliminary fact finding in this chapter leads to a number of tables. The tables provide an overview of the groundwater situation, its users and the possible impacts of use on other users and the groundwater dependent functions in the target area, as far as information is available. Evaluation of the answers provided in the tables should give a fair impression of major and minor problems and should lead to a ranking of key issues to be considered for coverage by the monitoring programme. The size and scope of the monitoring programme can only be determined after a more thorough investigation of the preliminary estimates in this chapter (see chapters 4 through 8). The following description should assist in evaluating the facts from the tables completed.

#### *Preliminary evaluation of aquifer conditions*

For evaluation of the potential of groundwater aquifers in the area, Table 3.2 or Table 3.3 will provide an impression of the proportions of aquifer and non-aquifer-environments.

- In areas of non-aquifer environment (e.g. basement areas), groundwater bodies may be limited to local zones or be non-existent. The need for a substantial and systematic monitoring programme is unlikely. If there is a local need groundwater monitoring for control of depletion or water quality degradation may be done in (some) single wells.
- For areas with aquifer environment the preliminary assessment of the groundwater situation and key issues should be given a follow-up of more detailed investigations.

If no zones with substantial aquifer environment have been found the evaluation may lead to a decision not to carry out further investigation but to undertake final reporting at this point. If further investigations are needed, division of the area into practical units, based on topography, catchment boundaries and aquifer zones should be considered. Table 3.4 is meant to provide an overview of extent, thickness, depth to water and stored groundwater volumes in the different aquifer zones.

#### *Preliminary evaluation of the groundwater situation*

A preliminary overview of the groundwater situation and its potential for use in different zones can be given by completing Table 3.5. Although the table is based on relative rough estimates it should already provide a basic idea of which zones may be promising for groundwater supply (sufficient recharge and stored volumes) and which zones may be less productive. The present use rate (abstraction divided by recharge) may also be estimated. In combination with the recharge estimates the table should provide a preliminary idea of where zones are already intensively used and where opportunities may be found for further development. Groundwater quality may be a limiting factor for certain uses.

Finally it should be stressed that a monitoring programme can help in quantitative assessment of the annual recharge and in determining the potential for further development with much more certainty. Providing the data for assessment and management of water resources on a regional scale is one of the objectives of the reference groundwater monitoring network.

#### *Evaluation of potential conflicts and observed trends*

Monitoring may be used as a tool to control the balance between matters of common interest (e.g. avoid unacceptable depletion or contamination of water resources versus abstraction for public water supply) or to control a balance between the interests of different groups (e.g. public water supply of cities versus urban water supply or water supply for irrigation). The priorities given to these aspects partly depend on political decisions.

- Table 3.6 and Table 3.8 show whether the different types of potential conflicts may occur in the different zones of the target area, simply by listing the users, the groundwater dependent functions



and groundwater dependent processes. The relative importance of the abstractions, functions and processes is represented by the given scores.

- Table 3.7 and Table 3.9 show whether the potential conflict situations have already led to observable negative trends. Not all trends may have been captured. For instance the impact of different groundwater suppliers on each others production can only be found indirectly.

The conflict situations may be analysed for the whole area as well as for the separate zones. As far as the groundwater monitoring network is concerned, the key issues may be inventoried for the area or for groups of zones. The priorities of the monitoring programme may be further differentiated per zone.

#### *Evaluation of the groundwater quantity situation*

The following types of conflict situations should be considered:

1. Conflict situations between groundwater abstraction and other groundwater dependent functions.
2. Conflict situations between groundwater abstraction and groundwater dependent processes.
3. Conflicts among different users. Different suppliers of groundwater may be in the way of each other.

#### *Evaluation of the groundwater quality situation*

The following types of conflict situations may be considered:

4. Pollution of the groundwater body by natural contaminants with consequences for water supply and groundwater dependent functions;
5. Threats of the groundwater quality by diffuse pollution from intensive agriculture or urbanisation with consequences for water supply and groundwater dependent functions.

#### *Rating of conflict situations – example for conflicts between groundwater abstraction for water supply and groundwater dependent functions in the same zone.*

A potential conflict situation is already there if one of the columns of users (groundwater abstraction) as well as one of the columns of groundwater dependent functions are positive (Table 3.6). The risk of conflicts is higher when more groundwater dependent functions are involved and when the given score of the functions is higher as well. The risk of an emerging conflict situation is also higher when more water suppliers are involved and when their score in the table is higher. Actual conflict situations already exist if observed trends in one of the columns of groundwater dependent functions (Table 3.7) are found positive. The situation is even more serious if that trend observation is already strong.

#### *Defining key issues*

A list of key issues can be defined on the basis of the need for further development and the conflict situations encountered in the target area and its zones.

- Table 3.5 and corresponding maps may be used for priorities regarding further assessment, development and control of the groundwater resources.
- Table 3.6 to 3.9 provide a preliminary impression of the various users, functions and processes that compete with each other in the groundwater field.

Rating the actual conflict situations will lead to prioritising the defined key issues of the list.

### 3.6 Defining a sustainable scale of monitoring

In order to determine to what extent a monitoring programme can be sustained, the available budget and the available staff capacity as well as the costs of network maintenance, data collection, analysis and management are needed. The costs may be different for each country and should therefore be verified locally. Chapter 8 and annex F provide detailed overviews of cost items. For rough estimates in this chapter the costs can be totalised.

#### ***Annual budget and permanent staff capacity for the monitoring programme.***

An annual budget and a permanent staff capacity will be needed to sustain the intended groundwater monitoring programme. The following information is needed:

1. Estimate of the budget available for the regular monitoring activities in the target area. This should be provided by the director/manager giving the assignment to design and establish the programme.
2. The number of staff available for maintenance of the monitoring network and regular data management, to be provided by the manager.
3. The costs of drilling, installation and development of replacement of existing observation wells can be verified with drilling companies. The lifetime of wells may be estimated from local enquiries among well owners.
4. The time and costs involved in data collection and sampling. These can be roughly calculated on the basis of frequency of field surveys, average distance, km-prices, equipment and consumables needed, etc.
5. The costs involved in preservation and laboratory analysis of groundwater quality samples.
6. The time and costs involved in data processing, data validation and storage, to be estimated on the basis of office work experience.

The size of a sustainable monitoring network can be calculated by distributing the available budget over “network maintenance (including replacement and adjustments)”, “data collection”, “laboratory costs” and “office work” and by dividing these sub-budgets through the unit costs of the different activities. After some redistribution of available means an average number of monitoring points will be obtained. That number provides a fair indication of the sustainable monitoring programme.

If two or more institutions, each with its own tasks and expertise are involved in data collection, data processing and evaluation, activities can be shared. In such case the capacity available for the programme can be totalised, taking into account a certain overlap and extra time involved in coordination and communication.

#### ***Separate budget for design and network improvement.***

A separate budget will be needed for a one-time design and investment in network expansion, assuming that the existing network is incomplete.

*Time and costs involved in design.* The time and costs involved in design depend on the size and complexity of the monitoring programme to be developed, the experience of the designer and the time consumed by proper communication (visits, meetings and preparation). The estimated size of a sustainable monitoring programme, the complexity of the situation and the information already available (sections 3.3, 3.4 and 3.5) are the basis for calculation of the investments needed in monitoring network design and network improvement by installation of new wells.

*Costs of network expansion.* If a one-time expansion of the network of available wells is needed an additional budget for installation of new monitoring wells will be required. The investments may be distributed over a number of years. The budgets needed for a one-time investment in design and installation of network improvements will have to be furnished apart from the regular budget for sustenance of the monitoring programme as defined earlier.

***Results expected from this chapter:***

*The chapter results in an overview of relevant facts and estimates that form the basis for decisions regarding the need, tentative scope and priorities of the desired groundwater monitoring programme.*

*The following items may be expected:*

- *A draft map of aquifer and non-aquifer zones of the target area. The map may be sub-divided into smaller units on the basis of aquifer types and (sub-)catchment boundaries for the purpose of a more detailed evaluation.*
- *A preliminary overview of the recharge, storage and actual use of groundwater for the different zones of the target area.*
- *A preliminary overview of actual or potential conflict situations on the basis of observed trends and potential interference of groundwater users, groundwater dependent functions and processes in the groundwater units of the target area;*
- *A prioritised set of key issues for the regional groundwater monitoring programme;*
- *A fair estimate of the size of monitoring network that can be sustained given the budgetary and institutional capacity available;*

*These should be collected together in an inception report which uses this background material to briefly set out the scope and scale of the proposed groundwater monitoring programme.*

## 4 Groundwater system analysis

### *This chapter:*

*The chapter focuses on analysis of the groundwater system and development of a conceptual model on the basis of available hydrogeological and hydrological information. The results of these activities constitute the technical basis for design of the monitoring programme.*

- *The description of the conceptual model should include the hydrogeological framework of aquifers, aquitards and aquicludes as well as the groundwater flow system within and between these formations. In addition, the conceptual model should identify areas of recharge and discharge from the groundwater system and should aim to identify the degree of interaction between groundwater and surface water*
- *Groundwater level records, if available, may be analysed for signs of over-exploitation.*
- *The analysis also covers groundwater quality which may give insight into the origin of the water and the chemical processes which might take place in the aquifers. Groundwater quality may also show signs of groundwater contamination related to land use.*
- *The conceptual model forms the basic technical framework for design of the groundwater monitoring network. In addition, first signs of deteriorating conditions are important for planning the monitoring programme.*

### 4.1 The conceptual model

The design of a groundwater monitoring programme requires basic knowledge with respect to the hydrogeological framework and the groundwater flow systems within the relevant aquifers, aquitards and aquicludes. The description of the understanding of the hydrogeological framework and the hydrological and hydrochemical processes occurring is called the conceptual model. The level of complexity of the conceptual model should be appropriate to both the objectives of the programme and the available data. In the early phase of groundwater assessment, when basic data on these items are usually scarce, it may only be possible to produce a rough concept of the real system. Later on, the level of complexity that can be depicted will increase as more data become available. Besides playing an important role in preliminary analysis of the groundwater system, the model is the basis for design of a groundwater monitoring programme. Data collected for the conceptual model, either existing or new, should be analysed for indications of potential impacts as well. So, development of a conceptual model should be one of the first actions of the design procedure, even if this first attempt is very simplified.

Creating a conceptual model of the groundwater system involves a review of relevant available data on topography, hydrology, hydrogeology and hydrochemistry and, in many cases, a focused programme of additional data collection. The model is based on interpretation of these data as well as on visual impressions from the field. To a large extent it represents a statement by the professional hydrogeologist on how the groundwater system being studied “works”.

There is no specific procedure that leads to a conceptual model for all types of situations and conditions imaginable. Instead the user will have to combine relevant information and field observations with knowledge, advice and common sense to define the appropriate conceptual model for his particular case and for the time being. Numerical groundwater models, even relatively simple ones, may help considerably in determining and understanding the pattern of groundwater flow. The preparation of a conceptual model may vary from simple to relatively complex, depending on the data available and the purpose the model will have to serve. If meant for monitoring, its preparation should be in balance with the scale of the monitoring programme and with the data available. For a

large-scale groundwater reference monitoring network the level of detail does not need to be very great. Description of the conceptual model does not necessarily require a lot of writing. A good illustration is often equivalent to many words (e.g. see example figures below). Furthermore it should be realized that a conceptual model is a statement of the understanding of how the groundwater system 'works' at the time of interpretation. That level of understanding usually increases with time as more details become available. Consequently the conceptual model and the monitoring programme will usually become more mature with time.

The following sections describe in a concise way the main components of the conceptual model and a procedure that may lead to an appropriate outcome.

## 4.2 Inventory of data

The data inventory phase often includes the following steps:

1. Collection and review of published documents about the topography, hydrology, hydrogeology, and related information of the area investigated;
2. Collection and review of site specific data. This may concern data about the aquifer systems(s) in question (lithological and geophysical borehole logs, pumping test reports, etc.), data on the groundwater system (groundwater levels and groundwater quality), groundwater related data of the surface water systems (base flow and spring flow) and, if necessary, data on precipitation and evaporation.
3. Collection of new information about the groundwater system. This could vary from a rapid reconnaissance survey using GPS and field test equipment to a more detailed field investigation with exploration drilling and pumping tests.

Studying published material on analogous systems (e.g. web search for papers) may be useful, especially when too little information is available on the groundwater system at hand.

## 4.3 Specification of the hydrogeological framework

Geological formations form the basic structure of the hydrogeological framework. Groundwater flows through this structure from infiltration zones to discharge zones. The hydrogeological framework usually consists of zones with a relatively high permeability (aquifers), zones with limited permeability (aquitards) and zones with virtually no permeability (aquicludes). As groundwater tends to take the way of lowest resistance, the bulk of groundwater flow is through the aquifers. Also the majority of observation wells for groundwater level and quality monitoring will predominantly be installed with their screens in the zones of highest permeability (the aquifers). The establishment of the hydrogeological framework is, therefore, essential information for the design of a groundwater monitoring programme.

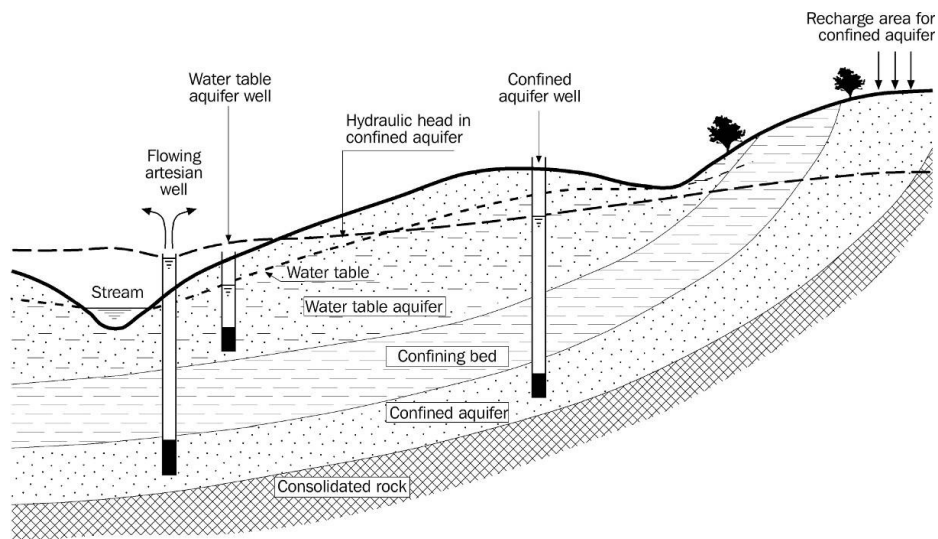

Figure 4.1: Schematic cross-section of a conceptual model

Large-scale hydrogeological maps and cross sections already exist of some countries. These maps and cross sections show the hydrogeological framework, the type of permeability (porous, fractured, fissured) and often groundwater levels and groundwater flow directions as well.

However in many countries hydrogeological maps do not exist as yet. In such cases the basic hydrogeological framework will have to be deduced from geological maps and cross sections of the target area. However, the information from geological maps and cross sections is seldom ready for direct representation of the conceptual model. It will then be necessary to create a tailored set of hydrogeological maps and cross sections. The following situations may occur:

- Regional geological maps do not exist or, because of their large scale, do not provide a sufficient level of detailed information. Additional data from borehole logs and groundwater samples will then have to be collected and interpreted. Also geophysical reports and information on the genesis of geological formations may help in creating the conceptual model.
- Further schematisation or simplification may be desirable. For instance, if aquifers are separated by discontinuous and thin low-permeability layers, they may be mapped together as a single aquifer system, often under combined names. In a similar way less permeable layers may be combined as a single aquitard, for instance if intermediate sand layers are relatively unimportant.
- Geological maps and cross sections may also contain information that is not necessary for the design of a regional groundwater monitoring programme. Unnecessary details should be left out, thus simplifying the overall concept.

The maps representing the conceptual model should be both balanced and realistic at a regional scale. Preparing them requires quite some experience.

Special attention should be given to the area where deep aquifer systems are exposed at the surface. These aquifers may come to the surface outside the target area or catchment, even in a neighbouring country. If that is the case, a considerable part of the recharge to the aquifer may come from outside the catchment. In practice this often leads to lack of data, which imposes limits on recharge and water balance calculations. Defining the potential for groundwater development of these aquifers will then depend more on the records of deep groundwater levels, which, in turn, may have implications for the groundwater monitoring programme.

If hydrogeological maps and cross sections do not yet exist, it is recommended that the conceptual model of the hydrogeological framework be visualised by means of the following items:

- A contour map (or maps), showing the extent and thickness of major aquifer systems as well as the lineament of fault zones;
- A minimum of two cross-sections perpendicular to each other, crossing the key parts of the aquifer systems and showing the sequence of aquifers and aquitards as well as the hydrological base;
- A table (or tables) listing the sequence of aquifers and aquitards from top to bottom, the type of rocks and calculated or estimated values of their hydraulic parameters (e.g. average and range). These values can also be shown on the maps.

#### 4.4 Analysis of groundwater flow

##### **Groundwater flow systems**

*Groundwater flow systems are defined as the spatial units or cells in which groundwater flows from the zone of recharge to the zone of discharge or withdrawal ( Figure 4.2).*

Groundwater flow systems are especially important for studies of the origin of the groundwater and interaction with its environment. A groundwater system may consist of several groundwater flow sub-systems, small and shallow ones embedded in large and deep ones. Shallow flow systems are usually drained by small streams, whereas the larger ones discharge into the major rivers or into the sea. These flow systems are separated from one another by “soft” groundwater divides or impervious layers.

Groundwater flow is gravity driven, causing groundwater to flow from areas of relatively high groundwater level under recharge zones towards the lower discharge zones. Path lines in a groundwater flow system connect the zone of recharge with the zone of discharge. The course of these lines is influenced by the hydraulic properties of the sub-soil, which makes aquifers the preferential flow path. This mutual relation between groundwater flow systems and the hydrogeological framework is scale dependent. Several small groundwater flow systems may be found in shallow aquifers. In a similar way, large and deep groundwater systems may penetrate several aquifers and aquitards.

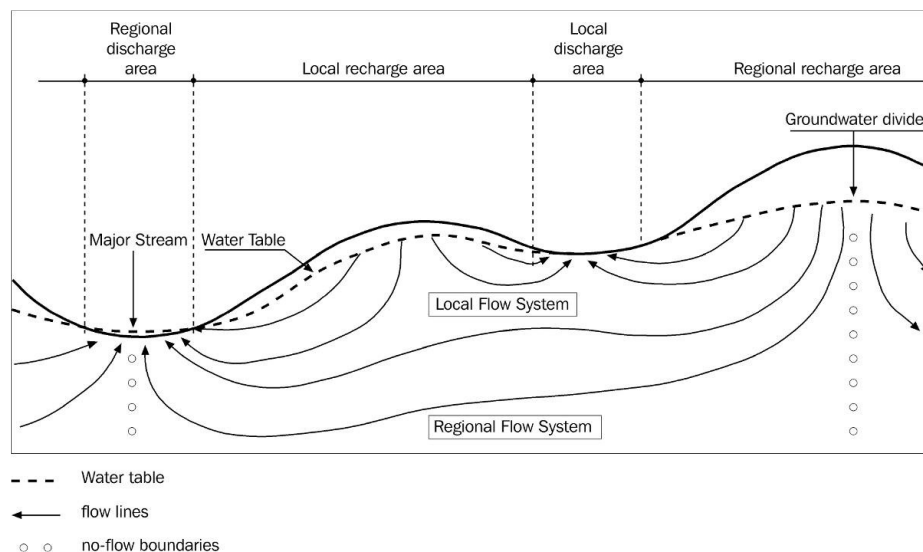



Figure 4.2: Schematic cross-section showing groundwater flow systems

Studies of groundwater flow systems and their path lines provide essential information for analysis of the evolution of groundwater quality, the possible impact of contaminants, and the effects of environmental measures. Residence times in large groundwater systems may be up to tens of thousands of years. Groundwater quality is then usually the result of a chemical interaction of groundwater with the aquifer matrix over a very long period. This long relation of the water to the chemistry of its environment can be used to distinguish different groundwater quality types (Ref). Small and shallow groundwater flow systems have relatively short flow lines and travel times. The quality of their water may show all types of recent influences.

**Shallow versus deep flow systems**

*Unconfined aquifers with shallow groundwater table.* In unconfined aquifers with a shallow groundwater system there may be a direct interaction between surface waters and the groundwater body. Where rivers, springs or lakes drain the groundwater system, the level of the surface water body roughly corresponds with that of the water table (Figure 4.3a). Only the hydraulic resistance of a river or lake bed (entrance resistance) may cause a small difference in these levels that is usually negligible at a regional scale. Where surface water feeds the groundwater system a similar situation may occur (Figure 4.3b). However, in recharge situations one should be aware that an unsaturated zone may be present underneath the surface water bed, disconnecting the surface water level from the groundwater table (Figure 4.3c). In the aquifers with shallow water tables, groundwater divides will often correspond roughly with surface water divides.

The above relation between surface water and groundwater levels can be used to draw the contours of the groundwater table map. In addition observation points of surface water levels can be used to supplement the network of groundwater observation wells.

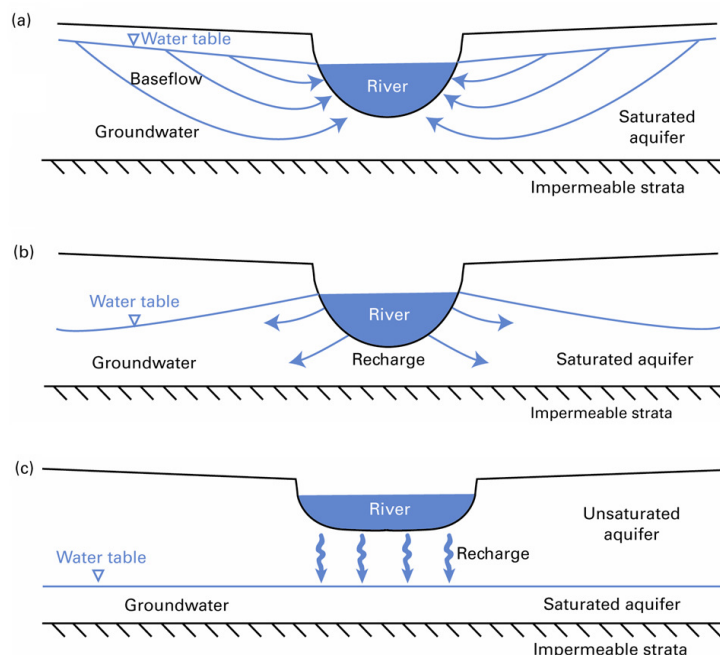

Figure 4.3: Examples of groundwater – surface water interaction

*Unconfined aquifers with deep groundwater system(s).* In areas with unconfined aquifers and a thick unsaturated zone (e.g. a water table deeper than 20 m) drainage channels may only discharge surface



water and have no relation with the groundwater body. The groundwater system will then be drained by the bigger rivers. In the area between the rivers only wells and boreholes of sufficient depth can be used to monitor the groundwater levels. The groundwater level measurements at these observation points constitute the basic data for studies of the groundwater flow.

*Confined aquifers.* In confined aquifers, groundwater levels measured in observation wells represent the hydraulic head at the depth of the screen. Monitoring wells or boreholes constitute the only way of recording the hydraulic heads in these aquifers. Deep confined aquifers may come to the surface outside the target area or catchment, even in other countries. If that is the case, groundwater system analysis may become more difficult and monitoring wells in the border regions will become important.

***Quantification of groundwater flow and storage***

*Groundwater balance calculations.* Groundwater balance calculations can be applied to quantify the different components of groundwater recharge and discharge as well as the accompanying changes (increase or decrease) in groundwater storage in a selected period. The groundwater balance may provide increased insight into the magnitude of different components and show where data are weak. The water balance should also help to identify whether the current situation in the aquifer is sustainable and to estimate the potential of the groundwater system for further development. Calculating a water balance is an important step and it should be possible in most cases to make a reasonable estimate of the key components. If this is not possible, then it suggests that the level of confidence in the conceptual model is likely to be low. Typical components of a water balance are given below (Table 4.1).

*Table 4.1: Groundwater balance with inflow and outflow components*

<b>Inflows</b>	<b>Outflows</b>
Direct recharge from rainfall	Discharge to rivers
Recharge from surface water bodies	Evapotranspiration
Urban leakage (mains, sewers)	Abstraction
Infiltration from irrigated land	
Lateral groundwater inflows	Lateral groundwater outflows
<i>Decreasing storage (falling groundwater heads)</i>	<i>Increasing storage (rising groundwater heads)</i>

Increasing storage (rising groundwater heads) occurs when the total inflows exceed the total outflows in the period considered. Decreasing storage occurs in the opposite case.  
 Note that many of these components are hard to measure directly and might need to be estimated (i.e. using per capita water consumption or generic pipe/sewer leakage rates).

*Use of numerical groundwater flow models.* Numerical groundwater flow models, even simple ones, may contribute considerably to the understanding of groundwater flow and groundwater quality development in the area considered. The models can be extremely useful in determining the directions and rate of groundwater flow. Sensitivity analysis using the model will show where the data are lacking or understanding is poorly constrained.

Groundwater models require a minimum of basic data on topography, aquifer framework and groundwater levels or depth to groundwater. If aquifers are not yet very well understood even a rough conceptual model, for instance including simplified aquifer systems, can be used to determine major flow directions. It is then important to describe the simplifications applied and the uncertainties that may be involved. If sufficient hardware, software, experience and budgets are available, an

appropriate level of groundwater modelling in support of groundwater monitoring design is recommended.

## 4.5 Assessment of groundwater quality

A review of available hydrochemical data will provide important insight into the status of groundwater quality in the aquifer, the chemical processes and changes occurring and their possible causes. Chemical changes may be due to recharge from rainfall, leakage from surface water, inflows from other aquifers, (considerable) evaporation, saline intrusion or contamination. Changes in groundwater quality along groundwater flow lines are also caused by chemical interaction between groundwater, soil and aquifer material.

Interpretation of the groundwater quality data will help in determining the origin and age of the water, thus supporting groundwater flow analysis, in identifying potential threats (saline intrusion or upconing, groundwater contamination, etc.) and in studying the perspectives and limitations of further groundwater development. This section only provides a concise list of actions needed for the assessment of the status of groundwater quality, a better understanding of the background mechanisms and processes, and preliminary identification of possible threats. Detailed methods for interpreting hydrochemical processes are described in many guides and handbooks (e.g. Davis & DeWiest 1996; Hem 1992; EPA 1989; Freeze & Cherry 1979) and will not be repeated here.

### *Aquifers with shallow groundwater flow systems*

Most shallow groundwater flow systems have short flow lines and travel times. This makes them vulnerable to rapid changes in groundwater quality, both in space and time, caused by local differences in land use. Experience has shown that groundwater quality may vary significantly between nearby wells. In contrast, samples taken from springs or streams draining the groundwater body will tend to show average values representative of a part of the system or the system as a whole. Where numerous similar, shallow aquifer systems extend over a large area, for instance coastal plains with repetitive drainage or irrigation systems, there may be many similar shallow systems at short distances, differing little from one another. To be (cost) effective, data collection in such a region should be conducted on the basis of a well prepared plan that considers similarities and differences between these systems. That plan for data collection may include a limited number of pilot areas (units), selected on the basis of the aquifer situation and differences in land use. Simple land use divisions could be: urban, agriculture with and without irrigation, pastures, forests and natural vegetation. The data collection plan may form the starting point for a future monitoring programme. For a general reconnaissance of the water quality, including water types, origin of the water and first indications of contamination, the following parameters should be analysed: Ca, Mg, Na, K, NH<sub>4</sub>, Fe<sup>c</sup>, Mn<sup>c</sup>, SiO<sub>2</sub>, HCO<sub>3</sub>, SO<sub>4</sub>, Cl, NO<sub>3</sub>, PO<sub>4</sub> (major ions). Analysis should also include direct measurements in the field of pH, EC, Temperature. For determining actual contamination, additional analysis of specific compounds is needed. Selection of the parameters should be based on information regarding the hydrogeological setting (e.g. F in Basement or Volcanic areas and As in major alluvial deltas or mining areas) or land use (e.g. B, Zn or organic components in urban areas).

### *Aquifers with medium deep and deep groundwater flow systems*

As discussed earlier (Section 4.4), collecting groundwater samples from aquifers with deep groundwater systems is only possible from deep wells and large, base flow dominated rivers (and occasionally springs) draining them. As the groundwater systems are usually large and deep with long flow paths and large travel times (hundreds to thousands of years) human influences on the water quality of the systems are generally limited to the upper zones. Trends in groundwater quality along flow paths will be important for demonstrating the natural processes occurring in these aquifers. For a good regional picture, a regular distribution of wells would be ideal. However, availability of wells may differ widely in these deep aquifers.

For a general reconnaissance of the water quality, including water types, origin of the water and indications of contamination, the following parameters should be analysed: Ca, Mg, Na, K,  $\text{NH}_4$ ,  $\text{Fe}^c$ ,  $\text{Mn}^c$ ,  $\text{SiO}_2$ ,  $\text{HCO}_3$ ,  $\text{SO}_4$ , Cl,  $\text{NO}_3$ ,  $\text{PO}_4$  (major ions). The proposed analysis also includes direct measurements in the field of pH, EC and Temperature. For determining actual contamination, additional analysis of specific compounds is needed. Selection of the parameters should be based on information regarding the hydrogeological setting (e.g. F in Basement or Volcanic areas and As in thick deltaic sequences).

#### *Coastal aquifers with saline groundwater*

Coastal aquifers usually have brackish and saline water at greater depth. The fresh/saline interface comes close to the surface near the coast and dips to greater depths away from the shore. The “interface” consists of a brackish, transitional zone with a thickness that may vary from some meters to tens of meters, depending on the dynamics of the groundwater flow system. Under natural conditions the fresh/saline interface may be at rest. However, groundwater withdrawal from the upper fresh water body may cause the interface to move inland and upwards, endangering the water wells and the environment. Therefore, groundwater wells close to the coast (e.g. within a range of 20 km) should be checked for the quality of their water, especially the chloride content. If records of deep screens are already available they may show chloride levels rising with time, which is a fair indication of saline intrusion. Unfortunately, reliable information about the depths of wells and their screen section(s) is often difficult to obtain.

If additional data are required, EC-values are good indicators of the salinity of the water in the range from brackish to saline water. As EC-values can be measured in the field they are excellent for a quick and cheap scan of the situation with respect to saline water intrusion.

***Results expected from this chapter:***

*The results of the chapter should be maps, cross sections and tables describing the conceptual hydrogeological model defined on the basis of existing information and field surveys. The information required includes:*

- A contour map (or maps), showing the extent and thickness of major aquifer systems as well as the alignment of fault zones in the area of interest;
- A minimum of two cross-sections perpendicular to each other, crossing the key parts of the aquifer systems, showing the sequence of aquifers and aquitards as well as the hydrological base;
- A table (or tables) listing the sequence of aquifers and aquitards from top to bottom, the type of rocks and the average value and range of their hydraulic parameters. These values can also be shown on the maps;
- A map showing groundwater levels and contours in the area of interest;
- Map(s) and/or cross sections showing the expected size and depth of major groundwater flow systems as well as rough indications of the recharge and discharge zones. Water divides between the flow systems and estimated flow directions should be indicated on the maps.

*If groundwater quality is to be part of the monitoring programme design, the following maps should also be prepared:*

- For deep groundwater systems, maps of the most relevant quality parameters or water types characterising the groundwater system(s) and showing trends in quality along flow lines;
- For shallow groundwater systems, maps showing selected pilot areas with the locations of sampled wells, in addition to tables or graphs showing the water quality in each pilot area.

*From coastal aquifers with saline groundwater the following information is needed:*

- A cross section (or cross sections) in a direction perpendicular to the coast showing the hydrogeological setting as well as the depth to the brackish water and the brackish/saline interface;
- A map showing contours of the depth to the brackish water and the brackish/saline interface. If depth information is not available, a map showing the spatial distribution of EC.

## 5 Analysis of institutional setting

### *This chapter:*

This chapter discusses the legal and institutional aspects that may determine success or failure of large-scale groundwater monitoring programmes for national and/or regional groundwater resources management. Successful implementation and sustenance of a monitoring programme depends to a great deal on sufficient legal and institutional embedding of the programme. This concerns support of the monitoring programme by laws, policies or regulations, clearness of institutional responsibilities and mandates as well as the need for sufficient capacity, knowledge and budgets. The better the support of the monitoring programme, the higher the chances of successful implementation. The following items are discussed and put in an international context:

- Relevant legal, institutional and administrative aspects concerning groundwater monitoring programmes;
- Water sector policy and legislation. The importance of defining the need for groundwater resources management and monitoring in national policies and laws or regulations of the water sector is emphasized;
- Responsibilities and mandates of sector institutions in relation to rights and obligations of stakeholder groups;
- Required technical capability of water institutions having the responsibility and mandates for groundwater monitoring;
- Information exchange and publication of monitoring results, a prerequisite for successful cooperation between institutions and support by stakeholders.

### 5.1 Institutional embedding of groundwater monitoring

Commonly aspects which regulate the use of all water resources are documented in a country's water law. Complementary, individual aims concerning what a government wants to achieve in the water sector may be written down in a water policy. Such legally binding documents should also cover aspects of groundwater monitoring because monitoring can only be effective if the responsible institutions have a legal mandate to conduct monitoring and at the same time must be able to implement resource management decisions which may arise from the results of groundwater monitoring.

Monitoring objectives may be different (groundwater quality, water level, monitoring of a defined area/aquifer, monitoring over a specific time period, monitoring of a specific parameter), so that the installation and operation of several individual groundwater monitoring networks may be required. It may also be necessary to orient monitoring networks along surface water or groundwater catchment boundaries rather than administrative boundaries so that they may cover different administrative constituencies (with their own institutional responsibilities for monitoring) or even cover several countries (monitoring of transboundary aquifers). Furthermore, monitoring networks may be operated either by the governmental or the private sector. With such different parallel monitoring networks functioning, it must be ensured that the individual monitoring objectives are still coherent and that management options can still be implemented.

In order to gain the highest benefit from monitoring information it is recommended to establish suitable structures for information exchange between the different responsible institutions, water user organizations, corporations and NGOs. It may be required to formalize this information exchange by a respective regulation or decree. Data may be collected by a number of different organisations.

Therefore, their systems need to be compatible in terms of standards, quality assurance, electronic access and data transfer.

The main aim of groundwater monitoring is to acquire data which help to adjust the management of (ground)water resources. In this respect it is important to disseminate the results of monitoring together with the conclusions drawn for (ground)water resources management among all stakeholders and the affected population in order to achieve agreement on necessary counter-measures. This may be for instance helpful if monitoring of groundwater quality reveals degradation risks or if groundwater level monitoring shows decline of water levels which pose a high risk for many stakeholders. The government or corporations may be obliged to publish monitoring data. It must be agreed between all involved stakeholders how and at what frequency data are to be published.

Often monitoring involves decisions concerning groundwater resources management of national interest. Therefore the highest demand for comprehensive groundwater monitoring information is most commonly generated at national level. The best option is to collect and analyze all monitoring data at a high-ranking governmental institution which is also responsible for such management decisions and has the backing to implement them. The overlapping of competences should be avoided.

## 5.2 Water sector policy and legislation

The water law of a country should encompass, among others, the following elements (modified after International Law Association, 2004):

- Objectives
- Administrative roles, responsibilities and control functions
- Definition of water rights (e.g. private or state ownership)
- The regulation of abstraction and injection rights (e.g. sewage water) and water uses
- The principles how water resources are managed (e.g. establishment of water management plans: Article 13 of the EC Water Framework Directive)
- Water protection issues like surface water and groundwater protection zones, effect on land uses (e.g. constructions that may affect the quality or quantity of water, and use of hazardous substances in the environment, etc.)
- Pricing of water and regulation of the water market
- Penalties, liabilities and responsibilities as well as duties of water users

Good governance was identified by the World Summit on Sustainable Development as one of the key factors for achieving sustainability. According to the UN Development Programme water governance refers to: ... “the range of political, social, economic and administrative systems that are in place to regulate the development and management of water resources and provision of water services at different levels of society.” The action plan developed at the G-8 summit in Evian in 2003 stated that the development of “appropriate legal, regulatory, institutional and technical frameworks” is essential to promote good water governance. Sustainable development can only be achieved if the rights of use along with the obligations of the users are negotiated and agreed among all stakeholders.

It is quite common that some issues which may affect the quality and quantity of water resources are regulated in other laws, such as environmental laws, land use planning laws, agricultural laws, etc. It must be ensured that those laws do not weaken the water law or its regulations in respect of the protection of water resources in terms of quality and quantity.

There may also be the need to adapt national or state law or regulations to international laws if those become superior, such as is the case in the European Community (e.g. Drinking Water Directive, Nitrate Directive, Water Framework Directive or the proposed directive on the protection of

groundwater against pollution). Also national laws may need to be modified if international or multi-lateral treaties are signed which regulate the management of water resources (e.g. in the framework of river basin management plans or transboundary aquifer development plans).

Groundwater monitoring may be required to be conducted by law for specific tasks, such as for instance baseline monitoring (e.g. according to the European Water Framework Directive), for groundwater protection zones (e.g. according to the German Federal States water laws), for contaminated sites and effectiveness of remediation (e.g. according to the Federal German Soil Protection Law), etc.

If laws do not provide sufficient detail for some water related issues, the establishment of water policies may be helpful, as was done in Jordan (WORLDBANK, 1999; MWI, 2003).

The Jordanian policy encompasses the following elements:

- Water Sector Policy
- Groundwater Management Policy
- Water Utility Policy
- Irrigation Water Policy
- Wastewater Management Policy

Concerning groundwater monitoring, it is helpful if some aspects are included in the legal framework, such as:

- The need for monitoring (why is monitoring required)
- Information objectives (what is to be achieved by monitoring)
- Roles and administrative responsibilities,
- Access rights (to monitoring locations),
- Costs (who has to pay for monitoring),
- Publication processes (of monitoring data; in which way are monitoring results published and who has a right to access the data),
- Consequences for groundwater resources management, etc.

In summary, groundwater monitoring will be most effective if the legal basis exists to implement measures which alleviate negative effects on the availability and quality of water resources and which have become obvious by monitoring. An appropriate legal, regulatory, institutional and technical framework should exist in order to provide good water governance. This legal framework must clearly define the responsibilities and control functions, the water resources management instruments and the responsibilities and duties of all water users.

### 5.3 Responsibilities and mandates of water sector institutions and stakeholder groups

Before a monitoring network is being set up it is helpful to analyze the responsibilities and tasks of all institutions, water user organizations, water utility companies, and NGOs involved in the water sector of an area (who does what and who has the legal mandate). This is a necessary action to obtain a good overview of the stakeholders in the water sector, their rights, responsibilities and data needs. It is also needed to identify problems related to responsibilities, mandates and priorities of institutions in charge of groundwater resources management and monitoring. Lack of proper mandates and assignments or duplication of mandates or tasks may severely hamper effective groundwater monitoring and exchange of data regarding groundwater resources. Improvements in these conditions may be needed to make the monitoring programme(s) work.



The division of responsibilities regarding groundwater management and monitoring is often very complex:

Responsibilities for surface water/groundwater and water quality/quantity management aspects are often divided among several different institutions (sometimes of different ministries) at different levels (national, state, district, municipality). Moreover, water companies, water user organizations and other NGOs may have their own monitoring networks.

Responsibility for baseline groundwater monitoring may lie at national, state, district or municipality level. However, in case of monitoring of water quality of drinking water sources (tap water, bottled water/drinks, milk) responsibility usually is with those companies providing them. Often water utility companies also have monitoring wells in the up-gradient catchment area of abstraction wells in order to be able to avert provision of polluted water resources and are obliged to submit their monitoring data to institutions which have the duty to supervise them.

Concerning monitoring of waste disposal sites, effluents and leakages from sewer lines and sewage treatment plants, mines, tailing dams, refineries, storage and processing facilities for chemical and hazardous substances, the responsibility may be either at national/state level (and be paid for by the operator) or may lie with the operator itself who then has the duty to furnish the data.

Monitoring of spills is commonly ordered (and conducted) by a governmental institution and must be paid for by the polluter (if the polluter-pays-principle is in place). In cases where contamination is widespread and cannot be attributed to a single source, such as agriculture, industry, urbanization, traffic or contaminated surface water sources, monitoring will have to be conducted and paid for by the government.

Monitoring of saltwater intrusion may be part of government's responsibility or, if it can be attributed to the over-abstraction by single users, be in the liability of these users.

There are many different models for the distribution of responsibilities regarding groundwater monitoring and it is, therefore, difficult to give general recommendations for them. The following may be considered:

The overall responsibility for managing and protecting groundwater resources which are of national interest should be with a high-ranked national or regional governmental institution. If groundwater management at these levels is to be effective also the monitoring programmes supporting these activities need to be the responsibility of that governmental institution. Certain tasks may be delegated, such as data collection, laboratory analysis and network maintenance. However, the responsibility for the national or regional monitoring programmes, supervision of the delegated tasks and the provision of budgets should be with the governmental institution in charge of groundwater resources management.

The best way to guarantee sustainable utilization of the water resources is to provide this institution with sufficient authority. To create a good basis for necessary cooperation the institution should be positioned at the same level as institutions responsible for management of relevant groundwater related sectors, such as land use and environment.

With respect to data exchange there should be a clear concept as to how the individual data needs and monitoring objectives of the various stakeholders of the water sector are going to be fulfilled. There should be a legal right to obtain the necessary monitoring information from different sources to meet these objectives (see also section 5.5).



Concerning the spatial set-up of groundwater monitoring networks it is preferable if the establishment of these networks is based on the boundaries of groundwater bodies or major surface water catchments rather than on administrative units.

## 5.4 Required technical capability of water institutions

Groundwater monitoring requires from an institution which aims to establish a monitoring network and wants to conduct monitoring and evaluation of monitoring data that it is qualified for this task and is able to conduct it over a long enough time period. This concerns personnel skills, the infrastructure and logistics as well as the funding.

Monitoring involves different technical skills which must be available or have to be developed. The assessment process and establishment of monitoring locations demands advanced hydrogeological understanding of the groundwater system which should be available among experienced hydrogeologists, whereas the design of suitable monitoring structures calls for knowledge concerning drilling and construction techniques. The fieldwork task of data collection is usually performed by technicians who have received special training in the use of the equipment. On the other hand the maintenance of the equipment and the rehabilitation of monitoring wells require more technical engineering skills. If large amounts of data are to be processed, an IT-expert may be necessary for installation and operation of the database. The processing of the data itself should be performed by hydrogeologists with special training in data processing and statistics. The publication of monitoring results may need an IT-expert for web-publishing if publication by these means is intended.

In respect of the infrastructure and logistics the institution has to offer the necessary means. This concerns the availability of suitable transportation facilities, e.g. for field inspections and maintenance, suitable office space and the availability of suitable means for data storage, transfer, processing and publication. Regarding the funding, it must be provided that the institution receives sufficient funds for the monitoring tasks over a long enough time period.

## 5.5 Information exchange and publication of monitoring results

From the beginning of monitoring schemes, it should be discussed what the monitoring results may be used for, who may need the data and what for, as well as how the monitoring results are going to be published. Such information exchange and publication may even be required by law. Therefore it is important that all possibly involved institutions, water providers and stakeholders are informed about the monitoring objectives and how they may obtain data and evaluation results. If monitoring data are needed from other institutions a formal procedure has to be established. In this context it is favourable if data are in the same formats or even the same database structure is being used so that those data can easily be integrated. Also the frequency of data exchange must be negotiated and agreed.

Concerning the publication of data, a suitable format should be agreed upon. When data are a public good, they need to be made available to the public regularly so that an immediate, quarterly or annual publication by internet may be necessary. In any case it will further the understanding and awareness if results are transparent to the public. It is recommended to publish annual monitoring evaluation reports. In this context it must be established who is allowed to or must publish his monitoring data and/or results, in which format, for which reporting periods and by what means (by internet or as printed version, downloadable, call centre for response to customer requests, etc.).

Concerning the access rights, governmental institutions may be either obliged to provide monitoring data free of charge to others or allowed to sell them. The latter may help them reducing costs but at the same time hampers transparency.

***Results expected from this chapter:***

The result of this chapter should be a critical assessment and evaluation of relevant aspects of the legal and institutional setting of the situation in hand that are considered essential for success of large-scale national and regional groundwater monitoring programmes.

Institutions being in charge of groundwater monitoring on a national or regional level need to have the right position, mandates, capacity and means to enable them to fulfil that task properly. Weaknesses in their position, absence of mandates and strong limitations of capacity or budgets may severely hamper a groundwater monitoring programme and make it unworkable.

The following conditions are considered essential for successful monitoring:

- A legal, regulatory, institutional and technical framework exists, which allows for sustainable management and protection of the water resources. The subject of groundwater monitoring is already receiving proper attention in the regulations or policy documents regarding the water sector.
- The responsibility for national or regional groundwater monitoring programmes is with the most suitable high-ranking governmental institution. Although some tasks of groundwater monitoring may be delegated, the final responsibility for the monitoring programme(s) should be with the governmental institution(s) in charge of management of the national or regional groundwater resources.
- The institution(s) having the responsibility and mandate for groundwater monitoring is (are) receiving the necessary backing and means from the government to fulfil these tasks.
- The capacity of the institution(s) conducting groundwater monitoring is adequate to fulfil its (their) tasks. Sufficient and suitable trained personnel, technical infrastructure, logistics and funding have been made available.
- Monitoring is coordinated with all other institutions working in the field of water resources management.
- Data exchange structures are established to optimize the benefit for all parties involved. The results of and conclusions drawn from groundwater monitoring are made public at regular intervals.

The above list may serve as a checklist for assessment and evaluation of the situation under consideration. The more of the above conditions are met, the better the chances for a successful monitoring programme. If some of the legal and institutional conditions are not (yet) fulfilled, measures should be proposed and pursued to improve the situation.

## 6 Design of a programme for groundwater quantity monitoring

### *This chapter:*

This chapter describes how a regional scale reference monitoring programme can be designed for groundwater quantity monitoring, following the procedure proposed in Chapter 2.

- Internationally accepted monitoring objectives for regional groundwater systems are listed and taken as a starting point for the design. The typical data needs related to these objectives are listed and discussed.
- The design procedure includes division of the area of interest into smaller units with typical hydrogeological characteristics and preparation of a basic map. Based on these characteristics effective monitoring strategies are proposed that may also suit limited budgets.
- Selection of monitoring points and network improvements are discussed and illustrated for three different options.

### 6.1 Monitoring objectives and data needs

In the early stage of groundwater assessment, groundwater data are usually needed for reconnaissance of the status and behaviour of the groundwater system as well as for establishing its potential for further development. Groundwater monitoring objectives in this stage are often formulated as follows:

1. *Characterisation of the groundwater system(s);*
2. *Identification of possible trends in relation to groundwater use;*
3. *Estimation of the potential for further groundwater development;*

Institutions responsible for national or regional groundwater development and control are the first ones needing the groundwater data. However, if groundwater exploitation is already a fact, also companies exploiting the groundwater and affected parties (other users, agriculture and environmental institutions, etc. ) may benefit from the data for purposes such as planning, licences or claims. Therefore, it is wise to make an inventory of interested or affected parties and list their data needs.

Because of their importance for national or regional development, large regional (sub-national) scale groundwater systems often have a higher priority than local-scale systems. Managing the large groundwater systems requires large-scale monitoring networks that are not suited for observation of local problems. Specific small-scale networks will then be needed to deal with these local problems. However, the regional network(s) will have to provide reference values for the local situations. This leads to a fourth objective, viz.:

4. *Provision of historical and reference values for detailed investigations*

The design of regional scale monitoring programme will be discussed in relation to the data needs to meet these objectives.

## ***1. Characterisation of the groundwater system(s)***

Groundwater flows by the force of gravity from recharge zones to discharge zones, where it is drained by springs, rivers or the sea. This process creates groundwater flow systems within the aquifers. Large aquifer systems may house several groundwater flow systems, each having its own recharge and discharge zones. The boundaries of the systems may correspond with separating layers (aquitards or aquicludes) or consist of groundwater divides within an aquifer. The position of groundwater divides between the systems may shift by changes in groundwater abstraction. Groundwater divides of large groundwater flow systems are usually quite stable, but their location may need to be observed if there are clear reasons for a possible shift.

Characterisation of the groundwater system includes:

- Demarcation of the extent of groundwater flow systems, the zones of recharge and discharge as well as groundwater flow directions;
- Estimation of the groundwater balance, including the volumes of the recharge and discharge;
- Analysis of the response of the groundwater system to natural and anthropogenic stresses.

The information needed for characterisation of the groundwater system(s) consists of:

- Maps showing the regional scale aquifer systems;
- Contour maps showing the regional pattern of groundwater levels, flow directions and flow divides within the aquifer system boundaries for each major aquifer identified.
- Maps showing depth to groundwater for the selected aquifers;
- Graphs showing the yearly fluctuation of the groundwater levels in response to climate and abstraction;
- Graphs showing the yearly variation in the discharge of the springs found in the area;
- Graphs showing the yearly variation of base flow of the streams leaving the area of the aquifers.

The above list shows what is ideally needed for characterisation of the groundwater system. In reality the data will often not be available, so priorities will have to be put on their collection (chapter 6.5). In the process of assessment of the groundwater resources and their potential for further development, the data collected will be combined with records of precipitation, evaporation, abstraction, etc. A detailed discussion of meteorological data was considered to be beyond the scope of the guideline.

## ***2. Identification of possible trends in relation to groundwater use***

Most known groundwater systems will be already in use for water supply or irrigation. For the future of the groundwater system and its users it is important to know whether actual use is sustainable or not and whether there are prospects for further development. In order to conclude whether the groundwater system is able to meet the demands of the users in the long term without too many negative effects, the response of the system needs to be observed.

The response of the system to abstraction shows in groundwater levels, discharge of springs and base flow of streams draining the system. With increasing abstraction of groundwater the groundwater levels will go down and the volumes discharged by springs and rivers will decrease. When these variables reach a lower but stable level after some time, there is still a balance between recharge and discharge components. Even then, groundwater levels may have become unacceptably low, causing wells and springs to dry up and groundwater dependent vegetation to vanish.

However when the measurements show a constant decrease over a long period (e.g. some years), there may be no final equilibrium, or only at too low a level. During the period of decreasing levels groundwater discharge, outflow and abstraction apparently exceed recharge and inflow causing a decrease in storage. In turn that may cause considerable damage to well fields, groundwater dependent agriculture and vegetation. The term “trend” has been used for decreasing (or increasing) groundwater levels or discharges occurring during a substantial period of non-equilibrium. Trends may be linear or non-linear, depending on the underlying processes.

The best indicators for trends in groundwater stored in the system “as a whole” are the natural discharge of springs and streams originating from that system, provided that these exist. Discharge records of these springs or streams will be representative for the groundwater situation in large parts of the aquifer system. For a more differentiated spatial picture of the declining groundwater levels that go with decreasing storage, a network of observation wells will be needed. Recording groundwater levels will show the response in different parts of the area covered. So, records of monitoring wells supplement the data from springs or streams and provide a more detailed image. As groundwater observation wells are usually only representative for the area around the well, either a number of representative measuring points or a distributed network of observation wells may be needed for observation of the groundwater system(s) (see section 6.2). The density of the network determines the level of detail as well as the costs involved.

In conclusion the stability of a groundwater system and its potential for further development can be reliably observed with the help of discharge records from springs, base flow records from streams and groundwater level records from selected observation wells. Both types of variables can be used as indicators of the stability and potential of the groundwater system. The best overall observation is achieved by combining both types of measurements.

### **3. *Estimation of the potential for further groundwater development***

Determining the potential for further groundwater development in an area requires information about the recharge, discharge and storage of groundwater.

1. *Rough first estimates.* Rough first estimates of further groundwater development potential can be based on the discharge and storage characteristics of groundwater in the area considered. The discharge components include discharge to surface water, subsurface outflow of groundwater and abstraction of groundwater. Estimates of exploitable groundwater need to take into account the non-exploitable part of groundwater (e.g. large parts of sub-surface outflow) as well as minimum rates needed for protection of environmental functions. Sufficient storage is necessary to bridge dry periods. The smaller the storage capacity the smaller the flexibility.  
Data needed include groundwater levels at representative points for monitoring groundwater storage and sub-surface outflow (if relevant), as well as discharge records/estimates of base flow and spring flow. Estimates of present groundwater abstraction rates are needed for a more complete picture of the groundwater discharge.
2. *Detailed assessments.* Detailed assessments of exploitable groundwater, for instance differentiating between zones or even sub-zones and between dry and wet periods, require more detailed datasets as well. These include records of precipitation and evapotranspiration, spatially detailed data on groundwater use, as well as distributed data on surface water levels and frequently observed groundwater levels in many more points.

It may be clear that detailed assessments are usually not the first priority in the early stage of groundwater assessment.

**4. Provision of historical and reference data sets for detailed resources investigation**

The reference function of monitoring points should be considered when selecting monitoring wells for the regional network. The monitoring points will be used to build historical data sets for regional groundwater management and control. These records will also serve as reference data for more detailed studies and for designing specific, often local, monitoring networks (Van Lanen, 1998). Hence, the observation wells should be representative for their particular area and the overall conditions of the groundwater system. They should not be under strong influence of stresses, such as caused by water well fields. These conditions are important when the basic network will be upgraded to a primary network. In the initial stage of the monitoring network it may not always be possible to meet these conditions because of a lack of suitable observation wells. However, the reference function should be kept in mind when selecting existing wells or future locations for the regional monitoring network.

**6.2 Design of groundwater monitoring to meet identified information needs**

**Mapping the area and dividing it into logical units**

Before the actual start of the design procedure of the monitoring programme, basic maps of the area showing relevant characteristics need to be prepared. The following items need to be prepared for further planning:

1. A division of the area considered into catchments and sub-catchments up to a degree that the smallest units are still regional scale units (suggestion: in total not more than 5-10 units, preferable minimum size 50-100 km<sup>2</sup>);
2. A division of the catchments into sub-zones on the basis of land surface elevation: mountainous, sloping area, valleys, plains;
3. Specified conceptual model(s) for each of the catchments/sub-catchments, including extent, thickness and depth of aquifer systems, (see also chapter 4 of the guideline);
4. A division of the aquifer systems into a) unconfined (water table) aquifers and b) confined or semi-confined aquifers.

The resulting maps will show a rough picture of the area considered and its smaller units. This picture of units may differ depending on the type of area. For instance if the area considered is a long strip of coastal plain, only catchments may form the units (Figure 6.1). However in mountainous area the result may be more complex, for instance a flood plain surrounded by mountainous valleys (Figure 6.2).

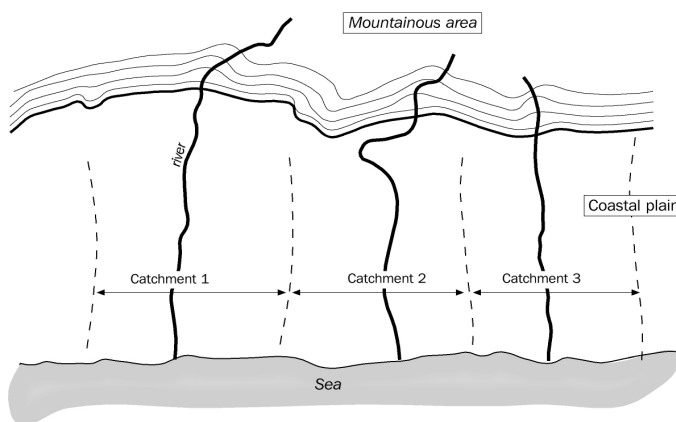

Figure 6.1: Example of catchments in coastal plane

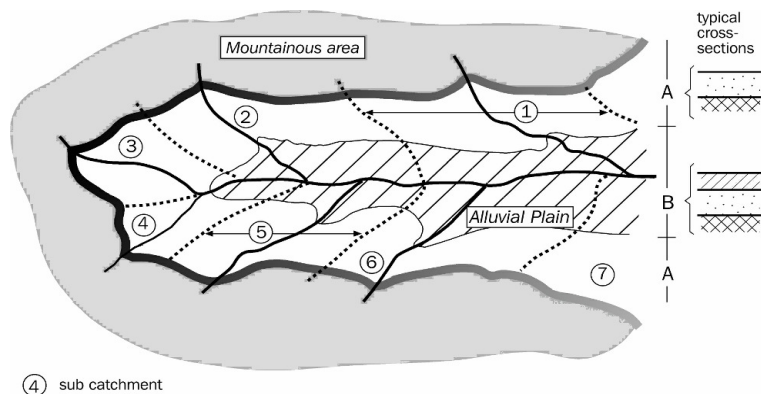

Figure 6.2: Example of catchments in mountain valley (catchment numbers not final)

The units distinguished will be used as the basis for further planning of the monitoring network.

### ***Design of a monitoring network for shallow groundwater systems***

In shallow aquifers the size of groundwater flow systems is an essential factor for the design of a monitoring programme.

1. If the shallow groundwater flow systems are many (e.g. several tens, hundreds or thousands, corresponding with intensive surface water drainage), then monitoring these systems would require a lot of observation wells, a considerable effort and high budgets. In such case “monitoring in pilot/example areas” should be considered. This can be done by selecting a number of these shallow systems on the basis of representative characteristics and by monitoring the relevant components, for instance including groundwater quality aspects. Management of the groundwater resources can then be based on measurements and experience with respect to the example areas.
2. If large shallow or medium deep groundwater systems are found, e.g. stretching over tens of kilometres, then the strategy of groundwater monitoring may be different:
  - The least intensive option of monitoring such aquifers is by monitoring only spring flow and base flow from the groundwater system, if that is possible (Figure 6.3). The discharge can often be related to the groundwater stored above the drainage base. In that way the data provide insight into the variation in storage. The overall effect of abstractions can be related to the discharge records, which gives indications about the sustainability of these abstractions. However, this monitoring option does not provide spatial information on groundwater levels. It also provides no data on sub-surface inflow or outflow of groundwater and is, therefore, not a suitable option if these components are substantial.
  - A second option is to combine monitoring groundwater levels at selected representative locations with monitoring spring flow and base flow (Figure 6.4). Monitoring wells should preferably be selected or installed in relatively high topographic zones, e.g. near water divides, where they provide the best information on possible trends in groundwater storage. The records can be used in combination with the base flow records and records of groundwater use as indicators of sustainable development. This option does not provide full spatial details on groundwater levels, but does provide a better spatial indication of the possible trends in storage and of the directions of groundwater flow. If sub-surface inflow and outflow are considered important additional monitoring locations may be selected where substantial sub-surface inflow and outflow is expected.
  - A third option is to combine a relatively dense network of monitoring wells with monitoring spring flow and base flow (Figure 6.5). This option provides full spatial information on



possible trends and on the directions of groundwater flow. Groundwater monitoring wells may be selected or installed at high spots as well as at the slopes and close to the rivers, if relevant for the regional picture. This option requires the highest budgets, but also provides the most detailed information: it allows for a spatial observation of groundwater level fluctuations and possible trends as well as for a detailed derivation of flow directions. The degree of detail is a function of the density of the network.

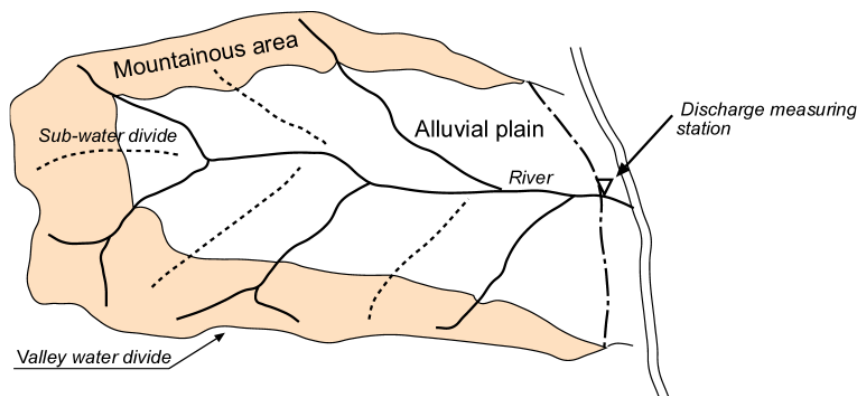

Figure 6.3: Monitoring network option 1

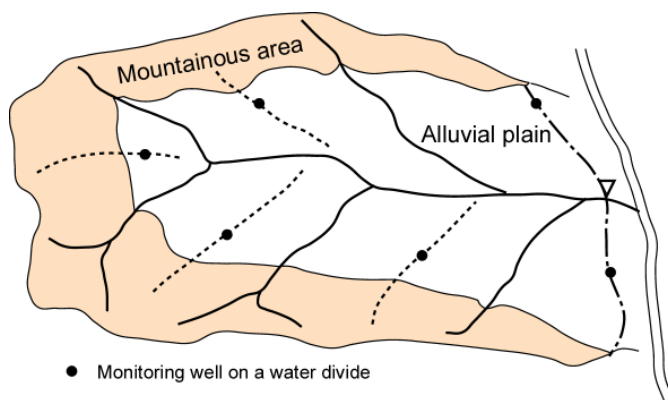

Figure 6.4: Monitoring network option 2

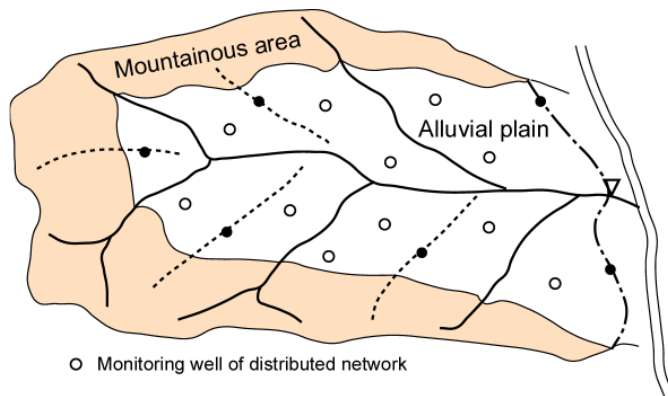

Figure 6.5: Monitoring network option 3



### ***Design of a monitoring network for deep groundwater systems***

Deep groundwater systems are usually large. The size of these large systems may reach from several tens to thousands of square kilometres (e.g. Sahara systems). Large groundwater systems are drained by big rivers or by the sea. Groundwater flows from the relatively high infiltration zones towards the deeper depressions at extremely low speed. Travel times may vary from thousands to tens of thousands of years.

If the water from these systems is not (yet) exploited, for instance because of quality problems, there may be no real need for a monitoring programme on groundwater quantity. However, if the groundwater systems are being used for water supply or irrigation, it will be worthwhile to know the status and possible deterioration of the systems. Reliable observation of such deep and large groundwater systems usually does not require a dense network of observation wells. At a distance from the groundwater well fields the spatial variation of groundwater levels in these large systems is often small, resulting in a smooth groundwater level surface. The groundwater level measured at some observation point is then representative for a relatively large area.

- For reliable observation of groundwater storage and possible depletion a limited number of well placed groundwater monitoring points may do (e.g. 1 monitoring well per 25 to 100 km<sup>2</sup>). Sites should be selected in infiltration areas and near the groundwater divide. In (semi)-confined aquifer systems also (some) observation wells may be needed in the exfiltration zones (seepage zones) as these provide insight into the vertical gradients that drive the groundwater back to the surface.
- For a more intensive observation of groundwater (e.g. rather well defined flow directions) a denser network will be necessary (for instance 1 monitoring well per 10 to 25 km<sup>2</sup>). The required density of the network and the required screen depth depend on the hydraulic aquifer properties.

### ***Frequency of observation***

The frequency of observation determines whether the data records obtained by monitoring reflect the response of the groundwater system well enough.

The response of the groundwater system to natural and human influences usually shows variation that may be classified as fluctuations and/or trends. Fluctuations may be divided into:

- Long term fluctuations, corresponding with (long) periods of relatively dry and wet years;
- Seasonal fluctuations, corresponding with wet and dry seasons;
- Short term fluctuations, corresponding with day by day rainfall or human influences.

Trends may be sudden (block trends) or gradual and are usually caused by human activity such as interference with river systems or over-exploitation.

Whether these fluctuations or trends will be found in groundwater level observations depends on local conditions, viz. the climatic zone, the surface water - groundwater interaction and the degree of human intervention. The degree of response to these influences depends on the hydraulic properties of the groundwater system, especially the degree of confinement and storage capacity of the aquifers. The frequency of groundwater level observation should be tuned to expected or measured response of the groundwater system and ambitions expressed in the monitoring plan. There is not a single best frequency of observation in a region or country, because the conditions (and ambitions) may differ from place to place. Some general considerations with respect to the frequency of observation are given below:

- In very dry climates (arid zones) where seasonal fluctuation is virtually absent, the frequency of observations may be very low, for instance 1 to 2 times a year. This will be sufficient to detect and control possible trends caused by (over-)exploitation.
- In humid climates, and to a lesser degree in semi-arid climates, the seasonal fluctuations can not be ignored. As regards long-term trends these fluctuations can be considered noise covering the required signal. Detecting and controlling a possible trend may then require somewhat higher

frequencies, e.g. 4 observations per year, to eliminate the noise. For studies of recharge of the groundwater system in these climatic zones an even higher frequency will be needed, for instance 12 – 24 times a year.

***Differentiation of network density and frequency of observation with respect to aquifer properties***

The response of the groundwater system to superficial influences is related to the depth and degree of confinement of the aquifer. Mathematical and geo-statistical studies show that the spatial correlation between the water level measurements increases with depth, especially if separating layers are involved. If aquifers are separated by a firm separating layer, the density of monitoring points in the lower semi-confined aquifer can be a fraction of the density in the upper aquifer (e.g. one third to one fourth) to give the same accuracy of interpolation. This property can be used to keep the investments in a monitoring network down by installing fewer deep monitoring wells. Another way of reducing the density of monitoring points in deep aquifers is by planning some rows of deep points in the estimated direction of flow, as was done in Flanders, Belgium.

Reducing the frequency of observation in deep semi-confined aquifers is also possible (less fluctuation in the deeper aquifers). However such a reduction may not lead to a significant decrease of annual costs, if the locations will have to be visited for observation of neighbouring shallow wells.

Table 6.1 shows relative differences of the network density and frequency of observation for aquifers of different type and depth, as a function of their response to natural influences from the surface.

*Table 6.1: Table showing possible differentiation of the network density and frequency of observation in relation to depth and degree of confinement of the aquifers*

Aquifer type	Details	Spatial variation (response to recharge)	Required network density for spatial image	Temporal variation (response to recharge)	Required frequency of observation for temporal image
Shallow (< 20 m)	Unconfined				
	- Dense drainage system	Highly variable	OOOO	Fast	OOOO
	- Limited drainage system	Modestly variable	OOO	Fast	OOO
	(Semi)-Confined	Modestly variable	OOO	Restrained	OO
Medium deep (20 – 100 m)	Unconfined				
	- Shallow water table	Highly variable	OOOO	Restrained	OOO
	- Deep water table	Modestly variable	OOO	Calm	OO
	(Semi)-Confined	Weakly variable	OO	Calm	OO
Deep (100 - >500 m)	Unconfined				
	- Shallow water table	Much shallow variation	OOO or (O)	Fast	OOO
	- Deep water table	Very low	O	Calm	OO
	(Semi)-Confined	Extremely low	O	Very calm	O

oooo, ooo, oo, o: indicators of the network density or frequency of observation, ranging from high to low

Data loggers are increasingly used to record groundwater levels in countries where wages are high. They can be programmed for different frequencies corresponding with the fluctuations expected. In some areas these loggers are used in a rotating manner for intensive studies of the groundwater level

fluctuation in order to decide about the best frequency of recording. It may be expected that the technical advantages of the loggers are not yet in balance with their costs in many low-income countries.

### 6.3 Considering monitoring options

Establishing a monitoring network will very often be a gradual and iterative process, in which the final result is reached after considering more than one alternative for improvement. In order to provide the basis for the decision making process, it is proposed to define and consider a limited number of different options. A consistent elaboration of these options will provide a much better insight into the information to be expected from the different options and the annual costs involved in the different options of the monitoring programme. This will ease selection of the most appropriate option for the prevailing conditions. The different options should be defined by the groundwater professionals in consultation with their managers. Defining the options together will have the advantage of avoiding wrong expectations. After settling the options, professionals can elaborate the results.

#### *Monitoring programme options*

Design options of monitoring programmes may differ in:

- Number of the area(s) to be monitored;
- Set-up of the monitoring network (discharge measuring points, observation wells, or combinations);
- Number of monitoring wells and vertical distribution of piezometers;
- Selected parameter sets (especially important for groundwater quality monitoring);
- Method of measuring (manual; recorders, combinations);
- Frequency of observation.

There is an almost infinite number of possible monitoring programmes. The challenge is to define and work out a limited number of realistic options. The approach is demonstrated with the help of a hypothetical example, viz. a valley with alluvial fill, surrounded by mountains and drained by a river.

In the following example *three options* of a groundwater monitoring programme for groundwater quantity monitoring are considered:

1. Only river discharges and spring flow are regularly recorded (Figure 6.3). This monitoring programme provides a rough indication of the stability of the groundwater situation, but provides no spatial information on groundwater levels and flow lines. This option will only warn groundwater managers of negative trends, when these have set in.
2. Recording river discharge and spring flow combined with recording groundwater levels in representative high topographical zones of the alluvial fill (Figure 6.4). This programme provides a much better indication of the groundwater situation, especially with respect to the variation of storage in the various parts of the alluvial fill. However the spatial image of the groundwater level contours may be relatively weak, just like the course of groundwater flow paths.
3. Recording river discharge and spring flow in addition to recording groundwater levels in a distributed network of observation wells spread over the alluvial fill (Figure 6.5). This programme provides a very strong indication of the groundwater situation in the various parts of the alluvial fill. It also allows for a more detailed analysis of the groundwater contours and flow paths. As a consequence groundwater management can be conducted in a spatially differentiated way.

The three options are clearly different with respect to the degree of information they provide for groundwater management. However, by expending the monitoring programme the annual costs will also increase.

Further evaluation of different options including groundwater quality and institutional aspects is discussed in chapter 8.

## 6.4 Use of existing wells and planning new ones

For a *one-time observation* of groundwater levels as part of the reconnaissance survey, available wells can be measured. This will often lead to a groundwater contour map with varying spatial detail, viz. much detail where well distances are small, and little detail where distances are large.

For a *regular monitoring programme*, selection of existing observation wells should be based on the monitoring plan (or the different options of it) and on the properties of existing wells. Existing wells often form the basis for the extension of monitoring programmes, especially in the early stages. If different options are considered, in principle also different selections can be made. However, in practice a situation with plenty of wells to choose from seldom occurs.

The monitoring plan or its options (section 6.3) will show the preferred locations of monitoring wells for different components of the programme. The plan usually takes into account the position of existing wells. It should be avoided to include local clusters of wells in the regional monitoring programme, except for a particular reason. These clusters do not substantially improve the accuracy of the regional image, while they do raise the costs of monitoring. For that reason, the most suitable and representative well from a cluster should be selected for monitoring.

With respect to the properties of existing wells, there will often be trade-offs in the selection process. Existing wells seldom fulfil all technical or logistical conditions set by the monitoring network design. So the question is whether or not to select a well that does not fully satisfy the conditions. Certainly at the start of a monitoring programme, using existing wells may be the only way to keep the costs of investments down. Minimum requirements are:

- the owner gives permission that the well can be regularly monitored;
- the details about the depth and construction of the well are sufficiently known;
- the details of the screen setting are roughly known;
- the well is complete and the water is clean or can be cleaned by purging;
- the hydraulic contact with the aquifer is good (the water level should recover within minutes after purging);
- the well can be protected from vandalism during the period that it will be used.

It is very important to produce a fact sheet of basic data of each well considered for observation, marking its location and basic data (depth, diameters, screen length, etc). This fact sheet (called well passport in some countries) allows proper selection of records for desk studies of groundwater level contours and graphs. For continuity of a monitoring programme it is necessary to make clear arrangements with the owners of wells concerning the frequency and time of visits and the period for which abstraction is ceased, if these wells are used for water supply (see also Annex C).

The location of new wells, their preferred depth and the position of the screen(s) will be given by the relevant option of the monitoring plan (section 6.3). The depth and position of the screens can be estimated on the basis of hydrogeological maps of the area. A detailed position of the well screens can only be determined after drilling.

***Results expected from this chapter:***

The results from chapter 6 should be:

- An overview of the design options of the groundwater quantity monitoring programme that will be included in the feasibility evaluation (chapter 8);
- A map of the area or catchment, divided into sub-catchments (e.g. 5 – 10), each of them further divided into zones on the basis of surface elevation (mountainous, sloping area, valleys, plains).
- A map and table, showing the conceptual model for each sub-catchment or zone distinguished. The attached description should be clear with respect to the estimated depth of the water table and the interpreted degree of confinement of the aquifer system (water table aquifer, semi-confined, etc.);
- A map and table indicating the groundwater monitoring objectives for each sub-catchment or zone distinguished, as far as relevant.
- A map and table, showing the groundwater monitoring network design for each different option considered. The monitoring points should be indicated separately with unique identifiers. The type of the monitoring point and its depth range may be indicated by the symbol.
- A table showing the frequency of observation related to the objective, differentiated for each sub-catchment or zone.

## 7 Design of a programme for groundwater quality monitoring

### *This chapter:*

This chapter describes how regional scale reference monitoring programmes can be designed for groundwater quality monitoring, following the design procedure proposed in Chapter 2. Four most common objectives for regional groundwater quality monitoring are distinguished. Because of the regional focus of the guideline, local groundwater contamination problems requiring specific local networks have been excluded.

The following items are discussed:

- Design of a programme for systematic monitoring of the groundwater quality needed when changes due to large scale abstraction or water management measures can not be excluded.
- Design of special network components for monitoring salinity in coastal aquifers or specific parameters limiting groundwater use such as Chloride and Fluoride.
- Design of a monitoring programme for identification of possible contamination caused by diffuse sources of pollution based on land use and aquifer vulnerability.

### 7.1 Monitoring objectives and data needs

Groundwater quality is characterised by a large number of parameters, including physical, chemical and biological types. The interest in these parameters differs with the objectives of the analysis. These objectives may be of a general type, for instance “general groundwater characterisation” related to the actual situation and the potential for use, or may be more specific, such as conducting studies of groundwater quality under the influence of contamination or remedial measures. The complexity of groundwater quality problems usually increases with the intensity of groundwater development and so does the need for more specific data collection.

Users of groundwater quality data are institutions advising ministries of water, public health, agriculture, industry or environment (governmental institutes, universities, others) as well as private organisations and firms working for the water sector. For a detailed overview of the data needs it may be necessary to make an inventory of users, their groundwater related programmes and their specific requirements. However, in the early stage of groundwater assessment and monitoring, ambitions may not be quite in balance with the possibilities of investment, and priorities will have to be set.

Objectives for groundwater quality monitoring discussed in the guideline cover general characterisation and subsequent observation of the water quality of important groundwater bodies and identification of large scale, often diffuse, groundwater pollution related to land and water use. Local and detailed studies of contamination, requiring groundwater monitoring networks that are specifically adjusted to the local situations and circumstances, are considered to be beyond the scope of the guideline.

In the early stage of groundwater monitoring the following objectives may be considered for implementation:

1. Characterisation and observation of the groundwater quality of the most important regional groundwater bodies;

2. Determination and observation of the position of the fresh-saline interface between fresh and saline groundwater zones. This is mainly relevant for coastal aquifers or aquifers with connate water;
3. Determination and observation of the position of specific natural groundwater quality parameters limiting groundwater use (e.g. arsenic, fluoride, etc.);
4. Identification of groundwater quality effects from diffuse pollution sources, such as use of fertilisers or pesticides.

Identification and observation of groundwater contamination from *point sources* of pollution is not considered a first priority in the early stage of groundwater monitoring. It is not denied that large pollution sources may have a regional impact. However, design of a groundwater monitoring network for determining development, extent, concentration levels, etc. of the pollution plume requires a specific approach, based on detailed assessment and calculation methods. Addressing these mainly local pollution cases would take a disproportional amount of time, which was considered out of tune with the main objectives of the guideline.

The guideline on monitoring has also limitations with respect to the effects of *diffuse sources* of pollution (objective 4). Identification of that type of contamination in groundwater and relating it in a qualitative way to the source of pollution may be considered one of the potential functions of the proposed reference monitoring network. However, if it comes to further detailed assessment and statistical prove, for instance, of the precision of the proportion of contaminated groundwater, the reference network will usually be unable to provide sufficient data. Especially designed networks may then be needed to provide these data.

## 7.2 Design of groundwater monitoring to meet identified information needs

The above objectives are analyzed with respect to their general requirements regarding parameter sets to be sampled, particulars of network set-up and frequency of sampling. The approach with respect to the monitoring programme design as well as preparation of basic data differs for each objective. For that reason the full monitoring design procedure, including preparatory work, is discussed separately for each objective.

Groundwater situations can be very different and a monitoring programme can not be designed without a reasonable understanding of the groundwater situation at hand. That understanding is represented in *the conceptual model* that has been built on the available knowledge and information (see chapter 4). As far as particular regional contamination is concerned, also the potential causes need to be localized and reasonably understood. This may require preparation of additional maps, such as a map of land use for the purpose of identification of threats of diffuse groundwater pollution.

In many situations a relatively simple regional-scale numerical groundwater flow model may contribute significantly to the understanding of groundwater flow patterns. Such a model, if built with sufficient knowledge and experience, will show where groundwater systems are fed and discharged and what to expect from flow lines, flow velocities, residence times, etc. In turn, the depth of flow lines and the residence times will cast a better view on where groundwater quality may be influenced by recent activity (e.g. a period of less than 50 - 100 years) and where not. Although producing a groundwater model may not be a first priority, use of a groundwater flow model is recommended, wherever that is possible within the budget. However modelling should not consume a major part of the budget but be in balance with the whole design programme.



## 1. *Characterising and monitoring the groundwater quality of regional groundwater bodies*

Characterisation of the groundwater quality of regional groundwater bodies is necessary to determine the potential for groundwater development as well as to predict and control possible regional changes in groundwater quality due to groundwater abstraction or other external influences, such as large scale irrigation or civil engineering works. Where groundwater use may lead to conflicts of interest monitoring the groundwater situation will usually be a permanent need.

- *Parameter sets:*  
For a general reconnaissance of water quality, including water types, origin of the water and first indications of contamination, the following parameters should be analysed: Ca, Mg, Na, K, NH<sub>4</sub>, Fec, Mnc, SiO<sub>2</sub>, HCO<sub>3</sub>, SO<sub>4</sub>, Cl, NO<sub>3</sub>, PO<sub>4</sub> (major ions). Analysis should also include direct measurements in the field of pH, EC and temperature.
- *Network set-up:*
  - a) *Characterisation of the groundwater quality.* First characterisation of the groundwater quality in a region may be based on a single round of sampling, usually conducted in existing wells (production and observation), springs and streams found in the area. The ideal selection of wells is reasonably distributed over the area, while wells tap the aquifer(s) of interest. However, such a favourable situation will seldom be found and one may have to make use of all types of available wells, ranging from shallow dug wells to deep tube wells. It is necessary to make notes of the position and technical specifications of the wells, so that the first interpretation of the groundwater quality results can be based on sufficient data.
  - b) *Monitoring the groundwater quality.* Regular monitoring of the groundwater quality in regional groundwater bodies may be required if gradual changes in the groundwater quality situation, for instance caused by changes in groundwater abstraction or surface water management, can not be excluded. For regular and reliable observation it is useful to compose a “primary” monitoring network consisting of carefully selected wells and some newly constructed observation wells, if existing wells are not available. Selection of existing wells should be based on criteria regarding their technical properties as well as their accessibility, proprietary rights, etc. (see annex D). A permanent monitoring programme will lead to historical records that will be essential for further water management. Sampling the groundwater quality for this purpose does not put very high demands (see the above parameters) and can often be conducted in the same wells used for groundwater level measurements. However, well particulars, such as screen length and depth of penetration, have to be taken into account during interpretation of the results.
- *Frequency of sampling for monitoring purpose*  
The frequency of sampling depends on the rate of expected changes in the groundwater quality situation. For the purpose of minimum observation (no specific reasons to expect important changes) the frequency of groundwater quality sampling in regional groundwater bodies may be very low, e.g. sampling every five years or even ten years. Such a very low frequency may be adapted for deep groundwater systems that are only influenced by natural evolution processes. However, where larger changes are to be expected the frequency of sampling may be increased to, for instance, every year or every second year. Especially vulnerable shallow phreatic aquifers may require a higher frequency for general observation (e.g. every year), if they are under influence of abstraction or changing surface water management. The time of sampling may be adapted to the publication of the data, for instance for 5-yearly planning reports.

## 2. *Monitoring the position of the fresh-saline interface*

Monitoring the position of the interface between a fresh and a saline groundwater body is mainly relevant for coastal aquifers and aquifers with connate saline water. The position of the interface may



be relatively stable when the groundwater situation is governed by natural processes only. However, many fresh groundwater bodies are already being exploited for water supply, which causes risks of sea water intrusion and/or saline water upconing. Regular monitoring of the position of the interface will then be necessary.

- *Parameters*

The salinity of the water can be determined using the following methods. In increasing order of complexity they are:

- measuring both the specific electric conductivity (EC-value) and the temperature and calculating the EC-value for a reference temperature of generally 20 or 25°C;
- determining the amount of total dissolved solids (TDS);
- determining the concentration of major ions by means of chemical analysis.

The first method may be applied on site. The second and third methods are typical laboratory methods.

Below an EC-value of roughly 700  $\mu\text{S}/\text{cm}$  at 25 C° the water may be considered fresh and Chloride (Cl) and Bicarbonate ( $\text{HCO}_3$ ) are the major ions that determine the salinity of the groundwater in a homogenous hydrogeological and geochemical system. Above the limit of 700  $\mu\text{S}/\text{cm}$  at 25 C° Chloride (Cl) alone is usually sufficient to estimate the salinity of the water.

- *Network design*

The network for monitoring the effects of saline water intrusion or saline water upconing depends very much on the situation encountered. The better the understanding of hydrogeology and groundwater flow systems (conceptual model), the better the network set-up. However, even if little is known about the actual groundwater situation, a preliminary design of the monitoring network can be based on a rough version of the conceptual model and on sound reasoning.

In many semi-static situations the shape of the interface can be roughly predicted with the help of the Ghyben-Herzberg relation. The relation shows that the shape of the interface tends to be a mirrored version of the shape of the groundwater table, at a rate depending on the density difference between saline water and fresh water (e.g. Bear and Verruijt, 1987). Where the table is low the interface will be at shallow depth and where the table is high the interface will usually be at greater depth. For instance, for a saline water density of 1025  $\text{kg}/\text{m}^3$  and a (standard) fresh water density of 1000  $\text{kg}/\text{m}^3$ , the interface will be at a depth below mean sea level (reference level) equal to 40 times the height of the water table above it. This general relation can be used for planning the monitoring network set-up.

- In coastal zones, for instance, the fresh-saline interface in semi-static situations dips from sea level near the coast line to greater depths inland. The strongly two-dimensional shape of the interface along the coast can be effectively used for monitoring the position of the interface with a network consisting of selected wells, positioned in (some) rows perpendicular to the coast (Figure 7.1). In less regular shaped estuaries the situation will be more complex, but even then the relation can be used for designing a network.
- In a similar way the upconing interface at groundwater well field locations will tend to be a mirrored version of the totalized cone of depression. An effective monitoring network should then have a radial set-up with (two or more) rows of wells crossing the centre of the abstraction.

Ideally, wells used for this particular purpose of groundwater quality sampling should have their screens around the fresh-saline interface (Figure 7.1), so that trends can be monitored by regular sampling. The depth to the saline interface can also be determined with the help of cables having pairs of electrodes by making use of the relation between specific electrical conductivity and salt contents of the groundwater, or by using logging probes to produce continuous profiles of electrical conductivity.

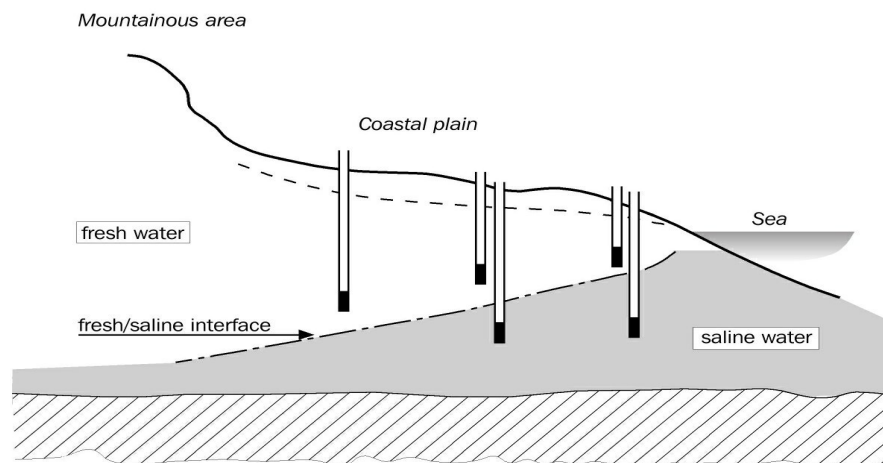

Figure 7.1: Network positioned perpendicular to the coast

- **Frequency of sampling**  
The frequency of sampling depends on the velocity of changes. Though movements of the interface on a regional scale are usually relatively slow, groundwater abstraction may locally cause much faster changes. The frequency of sampling may range from once every five or ten years in stable situations to yearly or quarterly in unstable situations and to every month in quickly changing situations.

### 3. **Monitoring natural groundwater parameters limiting groundwater use**

Even at low concentrations, *arsenic and fluoride* are dangerous to health and water which does not meet guideline values should not be used for human consumption. They are water quality parameters of natural origin that are released into groundwater from geological materials. These materials may occur at any depth. Even though the general geological environments which are prone to arsenic or fluoride problems can extend over very large areas (tens to hundreds of kilometres for fluoride in east Africa and arsenic in Bangladesh), within these areas concentrations can vary greatly over very short distances. Within these broad environments, the processes which release arsenic and fluoride may be mediated by localised conditions. Very low hydraulic gradients and consequent slow groundwater movement is often characteristic of such regions, especially the arsenic-prone deltaic environments. Sampling from adjacent wells or boreholes may produce very different results, which makes general regional monitoring difficult.

The position and extent of the affected groundwater may be determined through a one-time action by sampling water quality in wells and boreholes in the area that is geologically anticipated to be at risk. If insufficient boreholes and wells are available, extra exploratory boreholes/wells may have to be drilled/installed. Lateral displacement of the constituents is restricted by the low groundwater flow velocities, and in natural circumstances the affected groundwater may have reached a more or less static situation and regular monitoring may be limited to sampling every few years. If groundwater flow is being influenced by groundwater abstraction the situation of the affected groundwater may be out of balance and the flow of affected water may take new directions. In order to manage such situations more frequent monitoring may be needed in a monitoring network throughout the affected groundwater. The frequency of sampling may then be increased to once per year or every two years. The spatial properties of the monitoring network will have to be adjusted to the position and movement of the affected groundwater.

In conclusion the location of groundwater affected by arsenic or fluoride can be determined through a one time action if no changes are expected. In a changing groundwater flow situation, a monitoring programme will be needed to observe and manage the situation. If the changes are estimated to be gradual and slow the frequency of sampling may still be relatively low (every few years). However, if changes are expected to be considerable, e.g. by strongly increased withdrawal of groundwater, the monitoring network and frequency of sampling should be locally adapted to the expected velocity of change.

#### **4. Identifying and proving groundwater quality effects from diffuse pollution sources**

Contamination of groundwater by diffuse sources of pollution is a serious problem in the upper, often relatively shallow, aquifers of many countries worldwide. Diffuse pollution may be caused by application of agrochemicals (fertilizers or pesticides) or by atmospheric deposition of NO<sub>x</sub>, SO<sub>x</sub> and metals. However, diffuse groundwater pollution may also be caused by many local sources of pollution spread over large areas, for instance in urban regions.

A common approach in monitoring and quantification of groundwater pollution is to consider the source, the path lines and the affected receptor(s) of the pollution (e.g. Water Framework Directive, EU, 2000). That approach is now applied, for instance in countries of the European Union.

Three main factors determine the groundwater composition under influence of pollution (e.g. Broers, 2002):

1. The type and load of pollution recharged into the groundwater.
2. The hydrologic path lines followed by the groundwater. These pathways determine which reactive sediments are encountered. The course of these pathways also determines the age distribution of the groundwater and the time available for chemical reaction with the rocks and for possible decay of contaminants (e.g. Engelen, 1981).
3. The reactivity of the geological formations through which the groundwater passes. Hydro-geochemical reactions between groundwater and rocks alter the composition of the groundwater.

Ideally, the network design for monitoring groundwater pollution should take into account all these factors. However, especially in the early stage of groundwater assessment and monitoring, available information will usually be too scarce to allow for a very detailed differentiation. Information on the type and load of pollution may be estimated from land use, for instance. Hydrological path lines may be deduced from the conceptual model (Chapter 4) and may be used to distinguish between the vulnerability of groundwater in shallow and deep aquifers or between that in phreatic and confined aquifers. The reactivity of rocks is still one of the greatest unknowns, at least in quantitative terms. Therefore, differentiation of the monitoring strategy with respect to the factors that influence pollution will only be possible as far as it is supported by the available information. Factors that are largely unknown can not be taken into account and may regrettably cover up the relations looked for, if such factors are relevant.

A simplified method of assessing *diffuse pollution* makes use of the concept of *characteristic or homogeneous area types*. The characteristic area types are typified by a combination of one or more factors that are considered relevant for the distribution of pollution in the observed groundwater system. For instance, if the pollution by fertilizers is considered, land use and groundwater system vulnerability may be selected to be the potential relevant factors for the degree of pollution. Different types of land use may then be used to classify the assumed differences in pollution load. The groundwater system vulnerability may be classified on the basis of groundwater flow direction, viz. groundwater recharge zones, transition zones and discharge zones exhibiting a decreasing risk of groundwater system pollution. Also the hydraulic resistance of the top layer or the soil texture may be used for classification of vulnerability. Each “characteristic area type” stands for a typical combination of a land use type and a class of groundwater system vulnerability.

After defining the characteristic area types, the area under investigation is divided into sub-areas corresponding with the above classification. The wells available in the area can then be split up into groups, each representing a characteristic area type. (Wells of a particular group may thus be found in various sub-areas of the same type). The degree of pollution found in the water samples of each group of wells is considered representative for a particular characteristic area type. If the number of wells in a group is sufficiently high the distribution of the groundwater quality parameter under study (e.g. nitrate or phosphate) in the samples of a group can be valued and visualised statistically.

This simplified approach allows for assessment of the groundwater pollution in various characteristic area types. The pollution in the area considered can be classified according to land use and groundwater system vulnerability, in an indicative/qualitative way if little data are available and in a more quantitative way if sufficient data are available for statistical analysis. This classification method provides a good basis for preliminary groundwater quality sampling campaigns as well as for the design of a more permanent monitoring programme. It can be used, for instance, as the basis for policy development regarding land use and application of agro-chemicals.

*Diffuse pollution from agriculture.*

Identifying and proving quality impacts from agriculture sources of pollution requires a critical approach with respect to monitoring. As long as there is uncertainty about the possible impact of applied fertilizers and pesticides on groundwater, a two-step approach may be proposed:

- *The first step* should focus on showing whether and where concentrations are above the given standards or guidelines and on proving whether there is a likely relationship between the source of pollution (application of fertilizers or pesticides in agriculture) and the quality of the groundwater sampled.
- *The second step* should focus on establishing a more quantitative relationship between the application of the chemicals, their impacts and the effects of possible remedial measures (reductions).

A decision regarding implementation of the second step may be subject to whether the results of the first step are positive.

*First step.* In order to identify possible pollution and relate it to land use, groundwater quality should be sampled in possibly affected areas and in reference zones (usually forests or areas with other natural vegetation). Applying the approach with characteristic area types (see above description) requires the following actions:

- Mapping the different types of land use in the area(s) of interest, for instance distinguishing between urban areas, agriculture (different crops), intensive pastures, woods or forests and other natural vegetation types.
- Dividing the area considered into sub-zones of different vulnerability based on information regarding the hydrogeological framework and the groundwater flow systems (see Chapter 4). For a preliminary assessment of diffuse pollution it may be important to distinguish between groundwater recharge zones, transition zones and discharge zones with a decreasing risk of groundwater system pollution. For similar reasons the texture and hydraulic properties of the top layer may be taken into account.
- Defining a limited number of characteristic area types on the basis of land use and/or vulnerability characteristics.
- Selecting groundwater wells in all characteristic area types distinguished. Both potentially affected zones and non-affected reference zones should be covered.
- Selecting chemical indicators. Sampling will have to include the parameters that are typical for the type of pollution looked for. For nutrients, mostly nitrate, nitrite and phosphate are relevant parameters. As regards pesticides the decision on relevant parameters requires an inventory of compounds that are being applied in agriculture practice in the area and are at risk of leaching to groundwater.

- Sampling groundwater quality in selected water wells and analyzing the samples for the parameters that are related to the expected pollution.
- Assessing and if possible quantifying the degree of pollution in the different characteristic area types distinguished.
- Proving that the concentrations found in potentially affected areas are significantly higher than those of reference areas and that they are likely related to the source of pollution.

The first step requires a “preliminary survey”: usually a one-time sampling campaign. The quality of the assessment depends very much on the number of suitable wells found in the different characteristic area types. (Suitable wells have their screens in the aquifer studied). Some characteristic area types may be well represented while others may be only scarcely represented or not represented at all.

*Second step.* The decision to take the second step in monitoring depends on whether pollution is detected in relation to its source and on the need to take remedial measures. Two situations may be distinguished:

- If no significant pollution is found (no parameters above the nationally or internationally accepted standards), the general reference monitoring network may be used for further observation of the groundwater pollution signs. If desirable, it may be improved with some wells in scarcely represented characteristic area types. The frequency of sampling needs to be adjusted to the expectations regarding possible changes. Sampling may be repeated every few years, depending on the expectations, the ambitions and available means.
- If serious pollution is found in (vulnerable) sub areas, it may be decided to significantly improve the existing reference monitoring network or to install a special monitoring network for permanent use. Such network should be specifically designed for observing regional and temporal trends in the groundwater quality and for monitoring the impact of possible remedial measures. The monitoring strategy requires formulation of policy/ management objectives (e.g. detection of excessive use of manure in groundwater), information goals (e.g. which nutrients, which areas, which depths) and precise statistical information goals (e.g. percentage of area contaminated with a relative precision of 10% at 95% confidence level).  
Providing guidance with respect to the special monitoring strategies and networks that are required for such detailed quantitative assessments of diffuse pollution would require comprehensive explanations which are considered to be beyond the purpose of this guideline.

#### *Diffuse pollution in urban areas*

Diffuse groundwater pollution in urban areas usually is the result of many local point sources. Experience shows that diffuse pollution in shallow aquifers caused by these local sources may vary considerably from place to place, even over very short distances. Hence, the wells selected for sampling are only representative at a very local scale (distances up to some metres). An effective way of data collection for policy development in such situations is to select some pilot areas (e.g. the size of a village) and sample the pollution and its local variation in the pilot areas during a special sampling campaign.

If groundwater in an urban area is seriously polluted, for instance with nitrates, policies directed at improving the situation may be based on the results of investigations in these pilot areas. Measures to improve the situation may include campaigns to increase the awareness of the population regarding the pollution sources threatening their groundwater and the ways to reduce pollution and protect the groundwater resources.

The sampling campaign may be repeated after some time to check the impact of the measures on the average concentrations or the median of the values of the indicative parameters.

*In summary*

In summary identifying and proving diffuse pollution in groundwater may be possible with selected wells from the general reference network, if these wells are representative and suitable. In order to prove that the diffuse pollution is significant and above the natural levels, sampling will have to be conducted in both potentially affected zones and potentially unaffected zones. The approach with characteristic area types allows for differentiation of groundwater quality monitoring in the area if relevant factors can be defined and classified on the basis of sufficient information. The method also allows for statistical analysis of the results, if the number of wells in the defined characteristic area types is sufficient. Finally the monitoring network can be evaluated and improved with the help of the method.

If the pollution is serious and the effectiveness of remedial measures has to be proven, the monitoring programme requires very precise formulation of the policy goals, information needed and statistical criteria for the results. Such goals may require special monitoring networks that put high demands on the monitoring wells. A comprehensive discussion of such special monitoring networks is considered to be beyond the purpose of the guideline.

***Possibilities to increase monitoring efficiency by differentiation of network set-up, determinand suites and sampling frequency***

Groundwater quality monitoring programmes may easily become very costly when designed for multiple objectives. Major cost components are costs of sampling campaigns and laboratory analyses, which are closely linked to the number of sampling points and the frequency of sampling. Especially when the available budgets are limited, a critical assessment of the information needs and of the possibilities to get maximum information at minimum cost will be necessary.

Some ways to keep the costs of a national groundwater quality monitoring programme down are the following:

- Limiting the monitoring programme to the minimum level needed to satisfy the monitoring objectives formulated by (national) groundwater management. This means specification of the information needs for each monitoring objective separately, specification of the area(s) and depth for which that objective is relevant and restricting the monitoring programme to the needs.
- Differentiation of the monitoring programme according to land use and vulnerability of the groundwater system. It is common practice to give a higher priority to groundwater quality monitoring in the areas that run a higher risk of being polluted. Deep groundwater systems that are well protected by confining layers need less surveillance monitoring than groundwater in phreatic aquifers. Also differentiation according to the types of land use (e.g. agriculture versus nature) is an accepted way to improve efficiency of the monitoring programme and keep its costs down.
- Setting limits to the chemical parameter sets (determinand suites) to be analyzed for each of the objectives. Limiting the number of individual parameters may not always lead to cost reductions as many modern laboratories have standardized procedures that cover complete determinand suites (Environmental Agency, 2002). However, differentiation of predefined determinand suites according to land use and groundwater system vulnerability may significantly increase efficiency and reduce costs.
- Restricting the number of monitoring wells to be sampled to an acceptable minimum needed to comply with the monitoring objectives selected. For instance, the density of wells used for a spatial image of the groundwater quality once in a few years may be relatively large, while aquifers at risk may be surveyed much more frequently in only a limited selection of indicative wells. The density of the *reference monitoring network* should be sufficient to assure that significant negative trends will be detected with a reasonable certainty. This means that a minimum of monitoring wells (not less than 10) will be needed in regional size groundwater



systems at risk of being polluted or in each of their most vulnerable characteristic units distinguished.

- Differentiation of a sampling programme with respect to the depth range of monitoring wells is possible if the monitoring wells or their individual piezometers penetrate into different aquifers or cover a large depth range. The sampling programme may then be differentiated according to the expectation that influences from the surface may reach these different aquifers or depths.
- Adapting the frequency of sampling to an acceptable minimum for standard monitoring and for detection of possible trends. There are firm indications that even relatively low frequencies of sampling (e.g. half-yearly or quarterly) may enable detection of a trend in contaminated groundwater (Environmental Agency, 2002). However a more accurate quantification of the average slope of the trend may require a higher sampling frequency (e.g. monthly) if the period for quantification is limited. So, intensification of monitoring may be needed where serious negative trends have been discovered. This may require a new set of monitoring objectives and special monitoring programmes.

A practical example of a sampling matrix proposed by the British Geological Survey is given in Table 7.1. (Environmental Agency, 2002). It shows how the sampling frequency can be efficiently adapted to the hydrogeological characteristics of the subsoil.

*Table 7.1: Matrix of sampling frequencies for differing aquifer and chemical determinand response behaviours, proposed by BGS*

			Hydrochemical determinand	
			Unresponsive	Responsive
<b>Hydrogeology</b>	<b>Slow flow</b>	<b>Outcrop</b>	3 years	6 monthly
		<b>Confined</b>	6 years	annual
	<b>Fast flow</b>	<b>Outcrop</b>	annual	quarterly
		<b>Confined</b>	3 years	6 monthly
			<b>Surveillance</b>	<b>Operational</b>

Explanation of terms used in the above table:

- Determinand: Chemical or physicochemical parameter which can be measured in an analytical laboratory
- Responsive: Determinands which may change rapidly in response to human impacts
- Unresponsive: Determinands which are not likely to change rapidly in response to human impacts
- Slow flow: Mainly intergranular flow
- Fast flow: Mainly fracture flow
- Standard: A determinand suite measured at all monitoring points
- Selective: A determinand suite measured at monitoring points only where a particular land-use occurs in the catchment
- Surveillance monitoring: Defined under the WFD as monitoring of a comprehensive range of parameters at least once per six years to supplement and validate the impact assessment procedure and to provide information for use in the assessment of long-term trends both as a result of changes in natural conditions and through anthropogenic activity
- Operational monitoring: Defined under the WFD as monitoring of a limited range of parameters undertaken at least annually in periods between surveillance monitoring for groundwater bodies defined as being 'at risk'
- At risk: Defined under the WFD as groundwater bodies at risk of failing to achieve good chemical status under Article 4 and Annex V

### 7.3 Considering monitoring options

One or more network options for groundwater quality monitoring may be considered for evaluation of feasibility. These different options should be defined by the professionals in consultation with the responsible groundwater managers. There may be several possible options, based on priorities with respect to selection of areas, objectives to be included, selection of parameter sets and frequency of sampling and analysis. The first screening, described in Chapter 3, will already provide a first indication regarding important issues and objectives. Further analysis of the groundwater situation, the institutional capabilities and the availability of wells (Chapters 4, 5, 6 and 7) will enable these options to be specified more clearly. It is important that the number of options considered is limited and that they differ in essential aspects and not in irrelevant matters.

The options for a groundwater monitoring network usually include existing wells as well as new well sites. Options considered should be listed, sufficiently described and be shown in maps and tables. In the first stage of feasibility evaluation, the maps showing the different options do not need to be very exact. Working with a (small) database of existing wells may considerably reduce the time involved in preparing the maps for different options.

### 7.4 Use of existing wells and planning new ones

For a *one-time survey* of groundwater quality, as part of the reconnaissance and characterisation of the groundwater quality situation, available wells can be sampled. This will often lead to groundwater maps with gaps and varying spatial detail, viz. much detail where well distances are small, and little detail where distances are large.

For a *regular monitoring programme*, selection of existing observation wells should be based on the monitoring plan (or the different options of it) and on the characteristics of existing wells. Existing wells often form the basis for extension of a monitoring programme, especially in the early stage of the programme. If different options are considered, in principle also different selections can be made. However, in practice a situation with plenty of wells to choose from seldom occurs.

The monitoring plan or its options (section 7.4) will show the preferred locations of monitoring wells for different components of the programme. The plan usually takes into account the position of existing wells. It should be avoided to include local clusters of wells in the regional monitoring programme, except for a particular reason. These clusters do not substantially improve the accuracy of the regional image, while they do raise the costs of monitoring. For that reason, the most suitable and representative well from a cluster should be selected for monitoring.

With respect to the characteristics of existing wells, there will often be trade-offs in the selection process, because existing wells may not satisfy all conditions. However, at the start of a monitoring programme, using existing wells may be the only way to keep the investment costs down. A number of minimum requirements, essential for both groundwater level and groundwater quality monitoring, have been listed in chapter 6.3. Additional requirements for groundwater quality monitoring are:

- the location of selected wells should be representative of the regional groundwater quality situation (areas near local sources of pollution should be avoided);
- the construction material of the well should be known and noted down in the well fact sheet;
- the diameter of the well should not be less than 2 inch (necessary to insert probes);
- the possibility of purging is an absolute need for wells that are not being regularly used.



It is very important to produce a fact sheet of basic data of each well considered for the network, marking its location and basic data (depth, diameters, screen depth and length, materials, etc). For continuity of a monitoring programme it is necessary to make clear arrangements with the owners of wells about accessibility. Owners may be interested in having a copy of the results for their own well.

The location of new wells, their preferred depth and the position of the screen(s) will be given by the relevant option of the monitoring plan (section 7.3). The depth and position of the screens can be estimated on the basis of hydrogeological maps of the area. The exact position of the well screens can only be determined after drilling.

***Results expected from this chapter:***

In addition to the results listed for chapters 4 (conceptual model) and 6 (groundwater quantity monitoring), chapter 7 should result into the following products:

- An overview of the design options of the groundwater quality monitoring programme that will be included in the feasibility evaluation (chapter 8);
- A map showing the catchment or area of interest with the groundwater quality monitoring objectives indicated for relevant zones distinguished (coastal zones, zones with specific groundwater quality).
- A map showing the design of the network for monitoring groundwater quality with a sampling programme including listings of selected monitoring wells and parameter sets, as well as a specification of sampling frequency(s).
- A map showing the design of the network for salinity control (if relevant), with listings of selected monitoring points and specification of sampling method (EC or ions or both) and frequency.
- A map showing the design of the network for specific parameters Fluoride, Arsenic, others (only if relevant), with listings of selected monitoring wells, and specification of sampling frequency.
- A map showing the design of the network of identification points for diffuse pollution, with a table of selected parameters and specification of sampling frequency. The maps will be based on land use and aquifer vulnerability.

*The latter three results are only required if they will be part of the monitoring programme. Several options of monitoring network improvements may be considered.*

## 8 Feasibility of monitoring programme options

### *This chapter:*

Chapter 8 focuses on the preparation of documents needed for the evaluation of the feasibility of different monitoring programme options or combinations of them. The following subjects are discussed:

- Definition of essentially different monitoring programme options. Options considered may include combinations of groundwater quantity and/or groundwater quality components.
- Calculation of a) the investments to be made in the monitoring network and b) the annual costs involved in maintenance of the networks (including replacement of wells), data collection and data management (storage, processing and validation of data). Example tables are included for the calculations.
- Evaluation of different options considered. A summary table containing the major items for decision making is presented and discussed.

### 8.1 Documents required

Decisions regarding establishment of a monitoring programme, or improvement of an existing programme, will generally be taken by representatives of institutions that have been assigned the tasks, mandates and finances for groundwater assessment and monitoring. Such decisions will require a well prepared plan showing the objectives and data requirements, the designed monitoring programme and its expected benefits and finally the costs and organisational requirements involved. In the preparation phase of the plan several options for improvement may be considered, each with its own level of information, required costs and organisational impact. It is assumed that the options will be prepared by groundwater managers and monitoring experts.

The following documents are essential for evaluation and decision making regarding establishment of the monitoring network(s) required:

1. A file containing maps showing the design of different monitoring network options to be considered for feasibility, with clear indication of existing and new monitoring wells.
2. A document showing a) the investments to be made in the monitoring network and b) the annual costs involved in maintenance of the networks (including replacement of wells), data collection and storage.
3. A scheme for evaluation of different options of the plan showing the options considered, and for each of these options a) the information expected, b) the institutional and organisational aspects involved and c) the investments and annual costs involved.

This chapter discusses in a concise way the selection of different options and preparation of the documents for evaluation and decision making. Examples of underpinning documents include tables for calculation of costs, and schemes for evaluation. For the sake of transparency, the examples discussed in this chapter have been kept relatively simple. In reality the options of monitoring programme improvement can be evaluated in a much more detailed way. For elaboration of the costs of one or more options a spreadsheet is attached as annex F.

## 8.2 Definition and preparation of monitoring programme options

If a hydrologist, hydrogeologist or water engineer is requested to present a plan for establishment or improvement of a groundwater monitoring network, he will need to be given clear indications regarding the level of investments that can be made as well as the annual budgets available for maintenance of the network(s) monitoring and data management. In addition the situation regarding personnel and equipment available for the jobs should be made clear. Within the framework of overall conditions, some different options for the monitoring programme can be considered for evaluation and selection. Options may differ in a number of ways, as listed below:

- *Scope and focus of the monitoring programme*  
The scope of the monitoring programme may differ in its major purposes. It may comprise groundwater level monitoring, groundwater quality sampling or a combination of both. Groundwater quantity monitoring may include spring and base flow monitoring (see options in chapter 6. In groundwater quality monitoring the programme may differ in objectives and range (see chapter 7).
- *Areas to be monitored*  
Instead of choosing a complete area for monitoring at once, a sequential establishment of monitoring programmes in different parts of the area may also be considered. For instance, zones may be selected on the basis of urgency of data requirements, linked to the severity of their groundwater problems.
- *Intensity of groundwater monitoring*  
The groundwater monitoring programmes may also differ in intensity. The programme may differ in the density of monitoring points in the network or the frequency of observation (see also chapters 6 and 7). With the help of geo-statistical methods it can be shown how the accuracy of a contour map depends on the number of observation points per unit of area. Unfortunately there are no simple rules of thumb to underpin that relation.

Selected options should differ in *essential aspects* based on clear vision and choices and they should be technically consistent. Gradual implementation of a plan will distribute the investments over a number of years but in the end lead to the same cost level. As designing a monitoring programme may involve a considerable amount of time and manpower, it may be useful to distinguish key points in the implementation process which will allow for discussion of options and draft plans with managers.

Decisions regarding the feasibility will require a plan, including maps that show the design of the monitoring network(s) for different options. The map(s) should show the position of existing and newly planned monitoring wells and their depth range. If more than one aquifer is involved the plans may be shown for each aquifer separately. The design of the monitoring network and the involvement of existing wells has been discussed in chapters 6 and 7.

## 8.3 Calculation of investments and annual costs

### *Calculation of annual costs*

In the given example (Table 8.1) it has been assumed that 3 options will be considered. Both existing wells and new wells will be needed for the monitoring programme. Also discharge measuring stations may be needed. The costs of upgrading existing wells may include cleaning, simple testing and small repairs such as the provision of sampling taps at the wellhead, as well as cleaning and protection of the site (e.g. providing a concrete base, a cap on the well, aprons, etc.) and possibly administrative costs. Where little budget is available such improvements may be omitted. The costs for new wells

comprise drilling, installation, development, site protection and possibly administrative costs. Unit costs for drilling and well installation depend on the depth and may, therefore, be given as average costs for different depth classes or calculated for each well separately.

The total budgets for upgrading existing wells and installation of new wells are calculated on the basis of the numbers of wells needed for different options. Calculations can be made with the help of spreadsheets. The precision of the calculations depends on the accuracy of unit costs. Unit costs may differ very much from one country to the other and will have to be estimated and checked for the local situation.

Table 8.1: Example table for calculation of investments of different programme options

Options:	Option 1		Option 2		Option 3		
	Unit cost	Number	Total cost	Number	Total cost	Number	Total cost
Items:							
<b>Upgrading existing wells</b>		n1		n2		n3	
- Cleaning, testing, small repairs, sample taps	x		x		x		x
- Site protection (concrete base, cap, aprons, etc.)	x		x		x		x
- Administrative costs	x		x		x		x
<b>Installation of new wells</b>		m1		m2		m3	
- Drilling – depth class 1	x		x		x		x
- Drilling – depth class 2	x		x		x		x
- Well installation – depth class 1	x		x		x		x
- Well installation – depth class 2	x		x		x		x
- Cleaning and development	x		x		x		x
- Site protection (concrete base, cap, aprons, etc.)	x		x		x		x
- Administrative costs	x		x		x		x
<b>Discharge measurement stations</b> (only if relevant)		p1		p2		p3	
- Installation	x		x		x		x
- Site protection	x		x		x		x
- Administrative costs	x		x		x		x
<b>Recorders</b> (only if relevant)	x	q1	x	q2	x	q3	x
<b>Total investments</b>			X		Y		Z

n, m, p and q: numbers of units involved

### Calculation of annual costs

The annual costs of a monitoring programme (Table 8.2) are made up of:

- annual costs of the measuring stations (including replacement and maintenance);
- annual costs of measurements (including salaries, travelling expenses, etc.);
- annual costs of data management (including salaries, office costs, etc.).

Estimates of annual costs of a monitoring programme do not require a great deal of knowledge and experience. However, it usually takes some time before the unit costs of the different items will become known precisely. Best estimates of unit costs are based on some years of experience. A difficult part is the estimate of yearly investments, as these depend on the estimated lifetime of wells and equipment, which is sometimes difficult to foresee. The yearly costs of replacement are calculated

by dividing the investments on installation of monitoring wells over the number of years of their estimated life time.

- For well protected monitoring wells the life time may be between 25 and 50 years.
- If monitoring equipment is used the annual costs of replacement should be calculated as well. The average lifetime is often limited to 10 or 15 years.

In groundwater level observation the yearly costs of using monitoring equipment should be valued against the expenses on observers. In many low income countries monitoring groundwater levels by local observers will be cheaper than by recorders.

Table 8.2: Example table for calculation of yearly costs of different programme options

Options:	Unit cost	Option 1		Option 2		Option 3	
		Number	Total cost	Number	Total cost	Number	Total cost
<b>Annual costs of replacement and repairs</b>							
- Monitoring wells	x	m1	x	m2	x	m3	x
- Discharge measuring stations (if relevant)	x	n1	x	n2	x	n3	x
- Measuring equipment (tapes, recorders, etc.)	x	p1	x	p2	x	p3	x
- Other							
<b>Annual costs of data collection and analysis</b>							
- groundwater level measurements *)	x	q1	x	q2	x	q3	x
- groundwater quality sampling *)	x	r1	x	r2	x	r3	x
- laboratory analysis *)	x	s1	x	s2	x	s3	x
- discharge measurements *)	x	t1	x	t2	x	t3	x
<b>Annual costs of data management</b>							
- groundwater level measurements	x	u1	x	u2	x	u3	x
- groundwater quality sampling	x	v1	x	v2	x	v3	x
- laboratory analysis	x	w1	x	w2	x	w3	x
<b>Annual office costs</b>							
			x		x		x
<b>Total annual costs</b>							
			X		Y		Z

\*) The unit costs should include the frequency of observation, the costs of travelling, etc.

The above type of calculation can be made with the help of spreadsheets. A detailed version of a cost calculation table is available from IGRAC.

## 8.4 Evaluation of groundwater monitoring programme options

The decision making process requires a clear overview of the monitoring programme designed, the expected performance of the programme (functions supported and possible limitations), the investments and annual costs involved and the expected organisational impacts. Table 8.3 shows an example of an evaluation table for a programme for groundwater quantity monitoring, based on the options shown in Section 6.3. The complicated part is to describe the expected performance of the programme. It is relatively simple to indicate which functions will be supported on the basis of the types and positions of monitoring stations available or planned. However, it is much more difficult to quantify the value of expected results if the network options considered differ in density of observation points.

Statistical and geo-statistical techniques can help to quantify the accuracy of calculated results, relating them to the density of the network or the frequency of observation. Examples are the accuracy of a contour map in relation to network density or the accuracy of temporal trends in relation to the frequency of observation. However, using these techniques effectively is time consuming and requires relatively high densities of data, which are usually not available in the early stage of groundwater monitoring. So, the accuracy of the network may have to be described in qualitative terms (see descriptions in Table 8.3). Apart from the costs also the organisational set-up may be a reason for preferences between options. Therefore it will be good to list these implications as well. It should be clear which limitations in manpower, knowledge or equipment may hamper the monitoring programme. If the monitoring programme requires co-operation between different institutions, the organisational aspects will have to be analysed as well.

The evaluation table shown in Table 8.3 shows an example of groundwater quantity monitoring options.

Table 8.3: Example table for evaluation of different options – groundwater quantity monitoring

Item:	Option:	Option 0	Option 1	Option 2	Option 3	Comments
	(existing situation)					
<b>Monitoring programme properties:</b>						
- number of existing wells used		n0	n1	n2	n3	
- number of new wells planned		-	m1	m2	m3	
- frequency of observation (observations/year)		x	x	x	x	
<b>Expected performance:</b>						
- Limited control of overall trends		+ -	+	+	+	
- GW level control in key points				+	+	
- Area-wide control of water levels					+	
<b>Costs involved:</b>						
- One time investments		-	x	x	x	
- Average annual costs		x	x	x	x	
<b>Expected organisation impacts:</b>						
- Personnel			x	x	x	
- Equipment			x	x	x	
- Knowledge			x	x	x	
- Other institutes involved			?	?	?	

Options of the groundwater quality monitoring programme can be evaluated in a similar way. However, the evaluation may be more complicated because of the larger number of variables. Options may differ in the coverage of the monitoring programme (monitoring objectives selected and area covered) as well as in the intensity of the programme (determinand suites, frequency of observation and density of the monitoring network).

Defining the most appropriate monitoring programme options for detailed assessment and evaluation of their cost/benefit relation may not be a simple task. However, the procedure proposed in this guideline (Figure 2.2) will gradually provide more insight into the groundwater quality situation, the key groundwater quality issues and the feasibility of different monitoring programme options.

The preliminary assessment of the groundwater situation (Chapter 3) should expose the potential sources of pollution threatening the groundwater system on a regional scale and the key issues that need attention in the monitoring programme. The procedure should also provide a rough indication

regarding the financial feasibility of different monitoring goals and functions. On the basis of that information the first priorities of the groundwater quality monitoring programme may be defined.

The monitoring programme options for final evaluation and selection should be limited to the priority monitoring goal(s) defined and should only differ in details. These details may be defined and elaborated with the help of Chapter 7, also using the information from Chapter 4. Options may differ in the number of sub-areas covered, the determinant suites selected or the frequency of observation.

If the groundwater quality situation is complicated and the available budget is limited, a phased start of the groundwater quality monitoring programme in time should be considered. Such approach will allow for more gradual investments.

***Results expected from this chapter:***

1. A file of maps showing the design of different monitoring network options to be considered for feasibility, with clear indication of existing and new monitoring wells. Options considered may include combinations of groundwater quantity and/or groundwater quality components.
2. A document showing a) the investments to be made in the monitoring network and b) the annual costs involved in maintenance of the networks (including replacement of wells), data collection and data management (storage, processing and validation of data).
3. A scheme for evaluation of different options considered. For each of the options it should list in a concise way a) the information expected, b) the institutional and organisational aspects involved and c) the investments and annual costs involved.

## 9 Implementation

### *This chapter:*

This chapter describes in a concise way the phase by phase process of implementation of a reference groundwater monitoring programme. Design and implementation of such a monitoring programme is a major effort requiring good planning, clear agreements, sufficient communication to ensure support from stakeholders, timely procurement of budgets, manpower, etc. Four phases have been distinguished, viz. orientation/inception, design, realisation and monitoring and data management. Wherever possible the chapter refers to relevant chapters and annexes of the guideline.

### 9.1 Introduction to the chapter

In practice successful implementation of a groundwater monitoring programme depends on many conditions. Some are: starting with a clear assignment, agreed objectives and a realistic planning, ensuring sufficient support of stakeholders, timely provision of necessary budgets, clear agreement on data exchange and common activities, etc. These conditions will not be fulfilled automatically but require active planning. If the general conditions are complex a phased approach may be applied. This chapter presents a phased approach suited for a relatively large monitoring project with several stakeholders. The procedure can be used as a checklist for less complex situations as well. Parts of it may be left out if they are irrelevant.

The suggested procedure consists of four phases that will be briefly discussed. The proposed phases are the following:

- Phase 1: Orientation/Inception;
- Phase 2: Design of the monitoring programme;
- Phase 3: Realisation of the network improvements;
- Phase 4: Monitoring and data management

The phases are described in a very concise way, referring as much as possible to the preceding chapters of the guideline.

### 9.2 Phase 1: Orientation and inception

An orientation and inception phase may be needed if the assignment for realisation of a monitoring network is substantial and complex, for instance if several stakeholders are involved with their own objectives (ministries, governmental institutions, regional organisations), if information has to be collected from different sources (governmental institutions, private companies, universities, etc.) or if international support has to be assured.

The inception phase covers a general orientation with respect to the roles, mandates and data needs and possible contributions of stakeholders as well as the availability of (secondary or specific) networks and data bases containing groundwater and related information. The inception report may cover:

- Terms of reference/assignment;
- Description of the inventory and orientation conducted;
- Review of relevant stakeholders and their interests;



- Concrete work plan for phase 2;
- Involvement of collaborating institutions;
- Proposal with respect to place(s) of implementation;
- A time schedule including activities and meetings;
- Estimated required budget and manpower for phase 2.

### 9.3 Phase 2: Design of the monitoring programme

Phase 2 is the design and evaluation phase of the monitoring programme. The phase cannot start without having a clear commitment about the available budget and manpower for the design of the programme. The design procedure has been described in chapters 3 through 8 of the guideline. In the procedure there is a need for key decision points, for instance when design options will be defined. At these points preliminary results will be presented and further activities should be agreed upon. A time schedule for the procedure including decision points could be the following:

- Investigation of general setting (step 3);
- Agreement on objectives, scope, planning and commitments;
- Conducting further investigations (steps 4 through 7);
- Preparation and presentation of intermediate results;
- Agreement on options to be investigated;
- Investigation of options and preparation of results (step 8);
- Agreement on final option.
- Making a concrete work plan for phase 3;
- Defining required budget and manpower for conducting phase 3.

### 9.4 Phase 3: Implementation of the monitoring programme improvements

Phase 3 concerns installation of new measuring wells, regeneration of existing points (if desirable) and arrangements regarding monitoring. Improvements may be completed in phases. Design of contracts according to a fixed format may be considered if the number of sites is large. The following items are part of this phase:

- Planning the operational aspects of network improvement;
- Field surveys for site selection;
- Negotiation with owners of the sites;
- Making contracts for installation of new wells, including drilling, well installation, well development and site completion;
- Making contracts for regeneration of existing observation points, including repairs, cleaning and site completion;
- Making contracts for preparation of discharge measuring stations (only if applicable)
- Control of drilling, installation, development and completion of observation wells.
- Installation of measuring equipment;
- Looking for, engaging and instructing observers for water level measurements.
- Administration of all site specific data (see also Annex E).

## 9.5 Phase 4: Organisation of monitoring and sampling

A groundwater monitoring programme may include several types of data (e.g. groundwater levels, groundwater quality, base flow and spring flow). The data may be collected by different institutions or even different units of them. For instance, recording data on surface water (the basic data for base flow assessment) may belong to the task of a hydro-meteorological organisation, while recording groundwater level data may be the responsibility of a hydro-geological organisation. In a similar way different types of groundwater quality data may be collected by different institutions. Monitoring and sampling may thus involve various institutions, each with its own tasks and objectives. Regular communication between these entities about the groundwater monitoring programme will then be necessary to ensure that eventually the right combination of data will be available for interpretation.

With respect to groundwater level measurements the organisation may often be less complex. Several forms of organisation are possible. Groundwater level measurements may be conducted by field crews of the responsible organisation, by local volunteers (e.g. local; teachers) or by a combination of both. Also use of water level recorders may be considered, but that may be a too expensive solution if budgets are low. Annex C provides more detailed information about different methods and equipment.

Groundwater quality sampling including field measurements, purging of wells, sampling, preservation and transport of samples, is a much more complicated activity and, therefore, requires experienced technicians. It also requires transportable equipment and is for that reason mainly conducted by a field crew with a van. The frequency of sampling is usually lower than that of groundwater level monitoring. Annex D provides more detailed information about different methods and equipment.

The data will have to be analysed (groundwater quality samples), processed, stored and validated. This requires good planning and agreements with laboratories. Also exchange of data may be desirable, so that data can be validated in combination with other data. In chapter 10 the guideline presents some guidance and additional information for these activities.

## 10 Data management: storage, processing and validation

### *This chapter:*

This chapter describes data management, including data storage, processing, presentation and data validation. Data management is especially important as a continuation of systematic groundwater monitoring, as it improves access and exchange of data, uniformity in storage and processing, and integrity of the data.

- The use of Electronic Data Formats is discussed and encouraged for data processing and storage;
- References are given to data manipulation and storage tools, commercial as well as low cost and free of charge software.
- The process of data validation is given much attention. The description covers standard operating procedures, quality assurance and control in laboratory analysis. In addition three levels of data quality evaluation are discussed and illustrated with examples.

### 10.1 Introduction to data management

Data management is a broad term that when applied to hydrogeological data, covers the lifecycle of data from “cradle to grave”. This incorporates how data are managed from the point of collection through to reporting of the data to stakeholders, and all of the intervening steps. These intervening steps include storage, processing, analysis and validation.

The purpose of a data management system is to allow for the effective use of the data while ensuring its integrity and providing a centralized repository for storage. One of the major consequences of not having a data management system is that the data cannot be fully trusted because they have not undergone any rigorous or defined validation efforts. Without a data management system, erroneous data can be introduced and errors can be inserted into existing data.

Examples from the field of groundwater quality sampling are:

- Groundwater is sampled incorrectly in the field, such as too few well volumes are purged prior to sampling.
- The groundwater samples are not preserved correctly on their way to the analytical laboratory.
- Samples wait too long before chemical analysis
- The laboratory fails to calibrate its analytical instruments and techniques.
- The recipient of the data does not perform a data quality evaluation.
- Errors are introduced into the data as it is imported into whatever method is being used for its storage. Typical errors include transcription errors through manually inputting data and unit conversion errors resulting in chemical concentrations orders of magnitude higher or lower than expected.

As a result, the final product in the form of a data or interpretive report may be seriously compromised in terms of integrity. The primary objective of a data management system is to prevent erroneous data being introduced into the system and to maintain the integrity of data once it is in the system. This chapter focuses on specific sections of a data management system and how they are integrated to provide data that can be used in a productive manner.

The aspects of data management presented here are:

- Data storage
- Data processing
- Data presentation
- Data validation

Whereas the first three processes are data handling processes, data validation is a quality assurance process aimed at improving the integrity of data. Data validation is a very important activity in relation to groundwater monitoring as it assures the quality of the data sets collected through the monitoring programmes.

## 10.2 Data storage

### *Standardization of data format*

Historically, groundwater data has typically been stored in formats such as spreadsheets, text files and other flat files resulting in an inefficient mode of storage. There are many reasons why this method of storage is not conducive to reliable data, the main one being that data cannot be retrieved, used and checked easily. Very often data are in different formats meaning that their immediate use is inhibited until some form of data normalization is performed.

This concern can be overcome by the adoption of a consistent Electronic Data Format (EDF), and its use is encouraged for the main reasons that it provides a means of distributing data amongst disparate parties and ensures a consistent format even if consultants or laboratories are switched in the middle of an investigation. A key part of selecting a suitable EDF is such that its use should not lock the user into one software system but should allow the user to switch freely between systems if he or she so chooses. Examples of non-commercial electronic data formats include:

- Association of Geotechnical and Geo-environmental Specialists (United Kingdom)  
[www.ags.org.uk](http://www.ags.org.uk)
- Water Well Inventory System (Canada)  
<http://www.ene.gov.on.ca/envision/techdocs/4197e.htm>
- California Assembly Bill 2886 (United States of America)  
[http://www.swrcb.ca.gov/ust/cleanup/electronic\\_reporting/docs/EDF%201.2i%20Training%20Manual.pdf](http://www.swrcb.ca.gov/ust/cleanup/electronic_reporting/docs/EDF%201.2i%20Training%20Manual.pdf)
- EPA Region 5 (United States of America)  
<http://www.epa.gov/region5/superfund/edman/index.html>

After adopting an EDF it is important that the user maintains a “data dictionary”. Data dictionaries are used by all EDFs and are essentially a look up table for all of the codes used within the EDF. Their use is required when performing hard copy to electronic verification. Database administrators setting up a groundwater data management system are encouraged to adopt an EDF, either from those listed above or one more suitable to their needs.

### *Data types*

Raw hydrogeological data can be described as being point data. The following description of point data is taken from Kovalevsky, V. S., G. P. Kruseman and K. R. Rushton (2004).

*“Point data are the data that are generated at a specific geographical point. In hydrogeological terms, this data may assume many forms. Examples are:*

- geological data, such as borehole logs;
- hydrogeological data, such as depths to water and yields;
- construction data, such as casing, piezometer, borehole development and costs;
- type of equipment, such as pumping equipment and recorders;
- geophysical data, including surface and borehole measurements;
- hydraulic properties of the aquifer(s), such as transmissivity and storage;
- water abstraction and groundwater level records;
- hydrochemistry;
- other information, such as topography and surface drainage.

*Even though many of these variables have spatial connotations, they refer back to the groundwater abstraction point and are, for that reason, grouped under point data. Examples of variables with spatial connotations in the above list include the geological log, which has a vertical dimension, and surface geophysics, which has both horizontal and vertical dimensions.”*

Ideally all of the information listed above should be stored electronically and in a central repository so that it can subsequently be processed in preparation for its presentation. However, storing the above data in a digital database requires a major effort, which may not be feasible in the first phase of groundwater assessment. In the case of limited budget, it is recommended to give high priority to electronic storage of groundwater variables (groundwater level and groundwater quality data), because the volume of these data will increase rapidly when monitoring is started and essential validation checks can be conducted much easier and faster through electronic processing.

### **Data manipulation and storage tools**

For groundwater studies where hundreds of wells may be involved, the number of laboratory analyses conducted may be manifold. The copious amounts of data that result from these studies have historically been stored in a database, or worse, a spreadsheet or, even worse left in paper format. These and related issues can be resolved by the use of a centralized groundwater data management strategy and it is therefore important that a data management plan is implemented during the planning stage of a project. The proliferation of computer hardware and software combined with adopting an EDF makes the centralized storage of data that much simpler.

This section gives examples of available software for different areas of application. IGRAC has developed an online database (Meta Information Module MiM) providing references to different free or low cost software tools for processing and presentation activities (see [http://igrac.nitg.tno.nl/ggis\\_mim.html](http://igrac.nitg.tno.nl/ggis_mim.html)).

#### Operating Systems

- Ubuntu Linux <http://www.ubuntu.com/>
- Mandriva Linux <http://www.mandriva.com/>
- Apple (at cost) <http://www.apple.com/>
- FreeDOS <http://www.freedos.org/>

#### Databases

- Base <http://www.openoffice.org/product2/base.html>
- MySQL <http://www.mysql.com/>
- PostgreSQL <http://www.postgresql.org/>
- Access (at cost) <http://office.microsoft.com/en-us/FX010857911033.aspx>

#### GIS

- GRASS <http://grass.itc.it/>
- ArcView (at cost) <http://www.esri.com>

#### Integrated Data Management Systems

- Terrabase <http://www.terrabase.com>
- MonitorPro <http://www.monitor-pro.co.uk/>
- Enfos <http://www.enfos.com/>
- GIS Key <http://www.giskey.com/>
- Equis <http://www.eathsoft.com/>
- Geotech <http://www.geotech.com/>

### 10.3 Data processing

Data processing is the mechanism by which point data (Section 10.2) is transformed into spatial information, time series or statistics. This task is usually reserved for or managed by the hydrologist or hydrogeologist. Examples of spatial information include:

- Hydrogeological maps. (UNESCO, 1083)
- Hydrostratigraphic cross sections.
- Groundwater elevation contours.
- Depth of the saline/fresh water interface.
- Hydrochemical distribution maps. (Hem, 1992)

The processing of data should allow for interpretation of the groundwater resource. Examples of the type of data processing that would be applied to the database include the following:

#### ***Groundwater levels***

Common ways of presenting groundwater level data are by means of contour maps (spatial image) or hydrographs (time series).

##### *Groundwater level contour maps*

Groundwater level contour maps show the water level elevation with respect to a reference level, usually mean sea level. Contour maps may be of a single date or show the average value over a period. They may show groundwater levels or depth to groundwater. Water level values should be plotted on the map along with the borehole identifier and separately for each distinct hydrostratigraphic unit. The date or period of measurement(s) should be shown on the map.

To illustrate lines of equal potential the data may be contoured either by hand or with the help of a contouring program. Care should be taken that only measurements from the same time or period and same hydrostratigraphic unit are used, otherwise misleading results will be obtained. It is not acceptable to use automatic contouring programmes without paying due attention to geological features that could influence the groundwater flow regime. Contouring packages do not “know” about faults, rivers and barriers to groundwater flow that affect the configuration of groundwater contours. The direction of groundwater flow can be drawn on top of the groundwater contour map by constructing lines perpendicular to groundwater contours. The direction of groundwater flow is from higher to lower elevation head and this can be illustrated by the use of arrow heads on the flow lines. Contour maps can be used for visual inspection of groundwater level data. Incorrect locations or erroneous water level values will show up in the map and should be checked (see paragraph 10.4 on validation).

##### *Hydrographs*

Groundwater level hydrographs show the variation of groundwater levels in time for a particular location (measuring point). They are a fundamental component of hydrogeological assessments as they provide a means of relating the impact of natural and human influences to the groundwater resource. For such studies it is common practice to plot precipitation on the secondary axis to provide a visual observation of the response of the groundwater resource to this event. Supplementary data

such as abstraction rates can also be helpful when interpreting groundwater hydrographs due to potential anthropogenic influence on the environment. Hydrographs also play an essential role in validation of the groundwater level data (see paragraph 10.5 on validation).

**Groundwater chemistry**

Water quality diagrams should be constructed to assess the water type. Classification and evaluation of water types is a key component to understanding the hydrogeology and should not be overlooked. It is recommended that at a minimum, graphical representation of the major ion chemistry is prepared using interpretive plots such as Piper, expanded Durov or Stiff diagrams. These plots can help characterize the groundwater and illustrate changes in the hydrochemical facies. Care should be taken to evaluate the water chemistry of samples for similar dates due to the temporal characteristics of the water. A water sample collected from a non-arid environment will likely exhibit different characteristics at the end of summer than it will during the rainy season.

**10.4 Data reporting and presentation**

Data reporting and presentation (often called data deliverables) are one end result of a groundwater data management system. This stage could be considered the most important component of the system because it is by distributing these reports that the foundation is set for raising awareness of groundwater related issues. The availability and accessibility of reports enables wide distribution to stakeholders, either to the public through publications such as water quality reports, within the government to highlight issues such as water usage and contamination issues, or to research institutions and universities. Dissemination of data also helps raise awareness of policy and research issues and as such distribution of data should be viewed as a core process.

Two fundamental types of groundwater reports exist; these are a data report and an interpretive report. This section describes the core components of each type of report.

**Data reports**

A data report is exactly as the name implies, purely a transmittal of (validated) data without any interpretation. The purpose of this report is to distribute data to interested parties and generally consists of tabulated and graphical representations of the data. The specific use of the report and the audience determine the frequency, information, detail, and content of the publication. For example, a well construction report would be a one time report, prepared for a client detailing aspects of the well construction method with the supporting data being information related to the wells such as:

- Identifier
- Location
- Drilling method
- Total depth
- Drilled diameter
- Casing type
- Casing size
- Screen type
- Screen slot size
- Screen interval
- Filter pack material
- Filter pack interval

In contrast to this one-time report, regulatory compliance may require reports to be submitted on a regular base, for instance yearly reports of groundwater level observations or quarterly reports of groundwater quality. The data report would include time series of data that would not be present in the first example.



It can be seen that the content of a data report varies depending on a number of factors, however, the types of data that are generally presented include a subset of the following:

- Groundwater data (levels and/or chemistry)
- Spring flow data (levels, discharge and/or chemistry)
- Stream flow data (levels, discharge and/or chemistry)

Certain basic rules should be considered for the graphical and tabular presentation of data, they are:

- Be clear, concise and legible;
- Ensure that only relevant data is presented;
- Be certain that necessary headings, labels, legends and notes are included to help understand the data.

### ***Interpretive reports***

An interpretive report uses the data report as a foundation to help provide a conceptual understanding of the hydrogeology and the evolution of groundwater quality. As is the case with the data report, the content of an interpretive report is not fixed. For an interpretive report, its content is likely to be determined by client requirements, legal and regulatory standards as well as the standards of the organization preparing the report. Although there is a wide variation in the type and content of interpretive reports, it is important that certain protocols are followed for the data analysis and modelling phases. A few general requirements are listed below.

With respect to the contents the report should describe:

- the purpose and scope of the report;
- the datasets used (locations, periods, etc.);
- the methods of reducing and interpreting the data;
- the models/formulas used, their purpose, limitations and assumptions;
- the results obtained
- conclusions and recommendations

With respect to the graphical and tabular presentation the report should:

- Be clear, concise and legible
- Ensure that only relevant data is presented.
- provide necessary headings, labels, legends and notes, to help understand the data.

### ***Distribution and accessibility of data and reports***

Distribution of groundwater data to decision makers, the public, and other stakeholders is vital to the success of a monitoring program. By developing the ability to communicate information about the groundwater system to such an audience the following may be achieved:

- Data and program deficiencies can be identified and solutions put forward to address them;
- Transparency and accountability for the work can be demonstrated;
- An environment of sharing can be fostered, and;
- A commitment to the aim of the work can be demonstrated.

## **10.5 Data validation**

Data validation is an integral process of a groundwater data management strategy; its purpose is to ensure the integrity of the data and ensure that errors are not introduced into it during the transmittal, reduction, storage, and subsequent manipulation of it. Validation of data is performed within various stages of the groundwater data management process. This section describes aspects of data validation



that should be applied as part of a groundwater data management strategy. Further reading for data validation techniques include Uil et. al (1999) and UN/ECE (2000)

### ***1. Standard operating procedures***

Standard Operating Procedures (SOPs) are reports or manuals that describe in detail the protocols for collecting and analyzing data. Their purpose is to improve data collection and data quality including uniformity, consistency and completeness of data sets. The protocols will enable technical personnel to understand and replicate the work at hand and force them to conduct complete and thorough surveys. SOPs should be established at the outset of an investigation to establish that work has been conducted to a consistent and scientifically defensible standard. Examples of standards bodies and an example standard include the following:

- American Society of Testing and Materials International (ASTM) <http://www.astm.org/cgi-bin/SoftCart.exe/index.shtml?E+mystore>  
ASTM D5092 Standard Practice for Design and Installation of Groundwater Monitoring Wells
- BSI British Standards (BSI) <http://www.bsi-global.com/index.xalter>  
BSI 1377 - Methods of testing for Soil for Civil Engineering Purposes

### ***2. Field data collection***

Certain steps can be taken in the field to ensure that basic hydrogeological information is captured. One common method for capturing these basic data is to ensure that field data sheets contain mandatory fields. For a technician collecting water level information, this mandatory information would include:

- Well identifier.
- Date and time of measurement.
- Depth to water level.
- Depth to bottom of well.
- Time since pumping stopped (for operating wells)
- Weather conditions.

For a field technician collecting water quality samples, additional necessary information would include:

- Time the permanent pump has been operating
- Length of purging period for sampling pump
- .....

Optional fields include remarks where the technician could note observations such as damage to the well or access concerns.

In addition to enforcing the collection of specific data elements, the data repository (database or GIS) should contain mandatory fields that match those on the field data collection sheets. By enforcing the mandatory nature of these fields, the data cannot be saved into the system unless they are completed. Other basic steps to maintain the integrity of the data include taking succinct and clear field notes and permanently archiving them.

### 3. *Laboratory quality assurance and quality control (QA/QC)*

Laboratory QA/QC procedures involve the process of running a series of diagnostic checks on the data to ensure its integrity. This task is the responsibility of the analytical laboratory and should include the following:

1. Does the data meet the reporting limits?
2. Do the sample identifiers match those sent into the lab?
3. Do the methods analysed match the inventory?
4. Have all analytes been delivered for each sample?
5. Do the results units match the sample matrix?
6. Were no additional methods run?
7. Are the analyte identifiers correct?
8. Is the logic correct for the reporting limit, minimum detection limit, and result?
9. Do the result qualifiers meet the logic requirements?

There are specific steps that the consultant can undertake to supplement the diagnostic checks performed by the laboratory. Such steps are listed below:

- The chain of custody (COC), which contains instructions to the laboratory regarding analysis of field samples, should be reviewed for completeness, accuracy, and legibility no later than one day after the samples have been sent to the laboratory.
- Any errors or adjustments to the COC must be immediately corrected and the laboratory informed of such errors or changes.
- The person responsible for communication with the laboratory should contact the laboratory at least once prior to end of holding times to ensure the work is proceeding as planned.
- When data packages are received from the lab the data package will be reviewed to ensure that the lab has complied with all information requested on the COC.
- Lab data should be received in the prescribed electronic format.
- The person in charge should review the laboratory QA/QC data to ensure that all precision, accuracy, and completeness protocols have been achieved.
- Possibly the most important check to be performed is between the EDD and the hard copy of the data received from the laboratory
- If there is a reason to doubt laboratory results, have (some of) the analysis done by a second laboratory.

### 4. *Data quality evaluation*

Data quality evaluation can be divided into three categories. These are checks performed by the consultant beyond any checks done internally by analytical laboratories.

#### 4a. *Primary validation*

This type of validation may be performed by visual inspection of the data and is intended to catch errors. Some examples in case of groundwater level data are:

- A recorded depth to water that is greater than the depth of the well.
- Errors due to a wrong reading (mistakes in readings by 0.5 or 1.0 meter)
- Errors due to a change in the height of the measuring point
- Errors due to assigning the groundwater level measurement to the wrong well or screen.

The visual inspection usually identifies suspect groundwater levels which can be confirmed to be erroneous only by comparing with other groundwater levels measured in the same area at the same time.

Another example of an erroneous value is given in *Figure 10.1*.

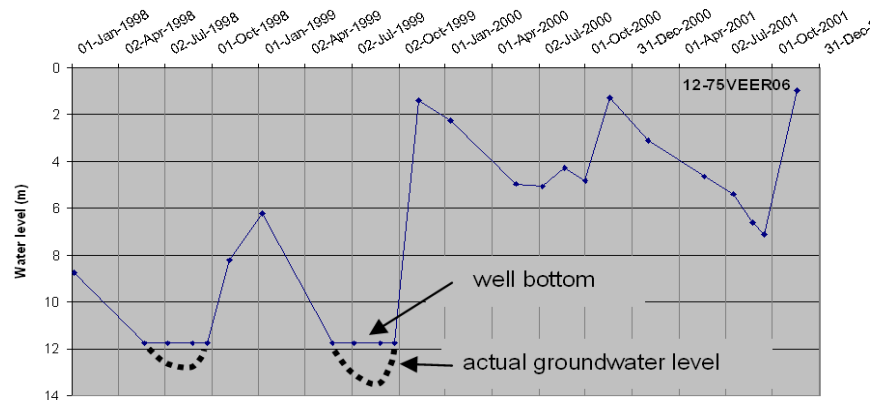

Figure 10.1: Hydrograph of well that occasionally falls dry

An example of misinterpretation of water level data is presented on Figure 10.1. Data presented on the graph for part of 1998 and 1999 is incorrect as the well was dry. The correct way to present these data is to add a note to the figure stating that the well was dry and the real groundwater level is unknown.

The correction of identified doubtful measurements is not straightforward. The problem always is: What was the correct value? The correction of measurements therefore should only be done in case the correct value can be determined without any doubt. In all other cases the value should be coded or flagged with the status: doubtful value.

Concerning *groundwater quality* data, specific data checks can be conducted beyond the steps described for determining integrity of data from the laboratory. Omitting these checks might lead to otherwise incorrect interpretation of data. The following are some basic checks that employ common sense evaluation of the data.

- Because groundwater is electrically neutral, the ratio of cations and anions (in meq/l) should be one. Although rarely one, a tolerance of 5% is accepted in most cases. If a balance of one is achieved it does not necessarily mean that the analysis is correct; if is possible that there is more than one error and that they cancel one another out.
- Ensure that all major ions have been analyzed; an omission of one may account for an unexpected cation/anion ratio.
- The numerical value of the total dissolved solids (mg/l) should be in the order of 70 % of the electrical conductivity ( $\mu\text{S}/\text{cm}$ ) (see Hem, 1992).
- Na and Cl ratio: Normally, in sodium dominated waters, most of the Na is associated with Cl, and thus, the ratio between Na and Cl (in meq/l) should remain between 0.8 and 1.2.
- EC and TDS ratio: For fresh water conductivity (EC, in  $\mu\text{mhos}/\text{cm}$ ) and Total Dissolved Solids (TDS in mg/l) usually obey the following relationship:  $\text{TDS} = \text{EC} \times a$ . Where 'a' ranges from 0.55 to 0.9, the constant 'a' is usually high for chloride rich waters and low for sulphate rich waters.
- COD and BOD ratio: Values measured for COD should always be higher than BOD values.
- Carbonate and pH relation: At pH values below 8.3 the  $\text{CO}_3^{2-}$  alkalinity (phenolphthalein alkalinity) should be zero.

#### 4b Secondary validation

This level of validation uses techniques to indicate deviating values. The results of this validation should be judged with knowledge of the hydrogeological regime that is being studied. The purpose of this step is to determine whether the selected values are errors or natural extremes. Simple statistical methods are available to check whether apparently erroneous values are statically likely.

Examples of validation steps for groundwater level measurements:

- Contour maps of groundwater level data for a certain period or date can be used to identify outliers. Outliers show up by a high concentration of contours around the location of the concerned well. The values causing the supposed discrepancies in the regional contour map should be checked again and may be found wrong.
- Preparing time series graphs with multiple hydrographs and the visual inspection of the graphs may show erroneous measurements. Comparing hydrographs would normally show similar trends and fluctuations and if not, may indicate erroneous groundwater level measurements.
- Some simple statistical methods are available to check groundwater level measurements e.g. deviation from the mean or the median. Data series can be checked for values, which differ more than three times the standard deviation from the mean or median.

For validation of groundwater quality measurements special diagrams, such as a Piper-diagram or a Stiff-diagram, may show deviating values. In a Piper-diagram (see also *Figure 10.2*), outlying points and in a Stiff-diagram, deviating shapes may indicate extreme water quality conditions. However such results may also indicate erroneous values for the constituting components, for example in the case that the concentration of a component was determined by closing the ion balance with a residual value.

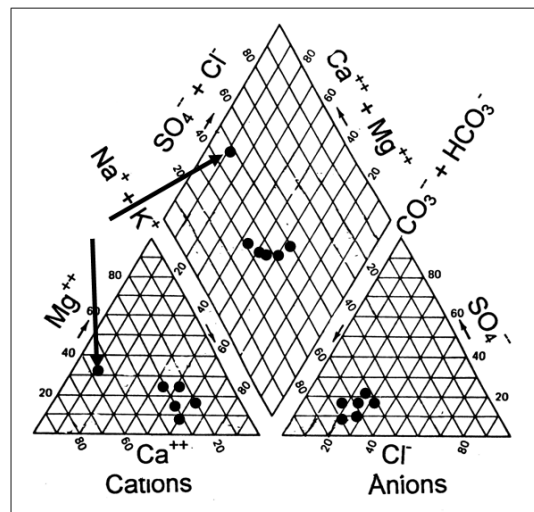

*Figure 10.2: Piper-diagram showing outliers*

#### 4c. Tertiary validation

Tertiary validation involves advanced techniques for analysis and validation of spatial and temporal data. This includes for instance advanced statistics and comparison of different data types. Advanced statistical methods can be used for detection of outliers. Parametric and non-parametric statistical trend detection techniques have been developed for time series to provide most likely estimates of the water level changes over time and the corresponding confidence interval. Determination of the outliers involves comparison of these estimates with measured levels. Helsel and Hirsch (1995) describe a number of trend tests for use in water resources assessment.

### *Common pitfalls during data processing and presentation*

The table below lists some frequently occurring pitfalls, checks and ways to overcome them.

*Table 10.1: Frequently occurring pitfalls, checks and solutions*

Potential Pitfall	Phase of Work	Checks and Solutions
Erroneous water level data	Field Data Collection	<ul style="list-style-type: none"> <li>Field technician should take a hydrograph into the field with the most up to date data set. After measuring the water level it should be plotted on the hydrograph to ensure that the data matches the seasonal fluctuations expected.</li> </ul>
Erroneous spring/stream flow data	Field Data Collection	<ul style="list-style-type: none"> <li>Field technician should make more than one measurement (e.g. 3) and take an average of them. A tolerance of variation should be established between measurements;</li> <li>Field technician should take a stream/spring flow chart into the field with the most up to date data set. After measuring the flow it should be plotted on the chart to ensure that the data matches the seasonal fluctuations expected.</li> </ul>
Unusually low or high analytical chemistry data results	Data Reduction	Check the following possibilities: <ul style="list-style-type: none"> <li>Unit conversion problem during data transfer;</li> <li>Change in laboratory detection limits;</li> <li>Change in laboratory;</li> <li>Change in analytical method;</li> <li>Improper purging and sampling protocols were followed.</li> </ul>
Unusual groundwater level contours	Data Interpretation	<ul style="list-style-type: none"> <li>Check whether all observation wells represent the same aquifer;</li> <li>Evaluate the operation schedule of extraction wells in the area.</li> </ul>

## References and related literature

- Bear, J and A. Verruijt (1987): *Modeling Groundwater Flow and Pollution*. D. Reidel Publishing Company, A Member of the Kluwer Academic Publishers Group. Dordrecht. Holland.
- Bogdanovic, S. (2001): *International law of water resources : contribution of the International Law Association (1954-2000)*, The Hague. – Kluwer Law International, International and national water law and policy series. Dordrecht. The Netherlands.
- Broers, H.P. (2002). *Strategies for regional groundwater quality monitoring*. Geographical Studies 306. ISBN 90-6809-342-8. Utrecht, The Netherlands
- Burchi, S. (1999): *National Regulations for Groundwater: Options, Issues and Best Practices*. – In: *WORLDBANK: Groundwater: Legal and Policy Perspectives*, Technical Paper 456, 262 p.; Washington. USA.
- Caponera, D.A. (1992): *Principles of Water Law and Administration – National and International*. 279 p. Balkema. Rotterdam.
- Davis, Stanley N. and Roger J.M. DeWiest (1996): *Hydrogeology*. ISBN 0 471 19900 1, John Wiley and Sons. New York. USA.
- El Nasser, H. & Macoun, A. (1999): *Groundwater Resources Management in Jordan: Policy and Regulatory Issues*. – In: *WORLDBANK: Groundwater – Legal and Policy Perspectives*, Technical Paper No. 456, 105-115; Washington. USA.
- Engelen, G.B. (1981). *A systems approach to groundwater quality – methodological aspects*. *The Science of the Total Environment* 21, pp 1-15.
- Environmental Agency (2002). *Development of a Methodology for Selection of Determinand Suites and Sampling Frequency for Groundwater Quality Monitoring*. National Groundwater and Contaminated Land Centre Project NC/00/35. ISBN 1857 05864X. Environmental Agency, Almondsbury, UK.
- EPA (1987): *Handbook - Ground Water*. EPA/625/6-87/016. Office of Research and Development. Cincinnati, Ohio, USA.
- EU (2000). *EU Water Framework Directive*. Official Journal L 327 , 22/12/2000, P1 - P73
- Freeze, R. Alan and John A. Cherry (1979): *Groundwater*. Prentice Hall Inc., Englewood Cliffs, N.J., USA.
- Helsel, D.R. and Hirsch, R.M., 1995. *Statistical methods in water resources*. *Studies in Environmental Science* 49. USGS, Elsevier, page 529.
- Hem, John (1992). *Study and Interpretation of the Chemical Characteristics of Natural Water*. United States Geological Survey Water-Supply Paper 2254.
- Hildering, A. (2004): *International Law, Sustainable Development and Water Management*. – 226 p; Delft/The Netherlands (Eburon Publishers).

- International Law Association (2004): *Water Resources Law – Berlin Conference 2004*. – 55 p.; Berlin.
- Jousma G. and F.J. Roelofsen (2004), *World-wide inventory on groundwater monitoring*, IGRAC, Report nr. GP 2004-1
- Kovalevsky, V. S., G. P. Kruseman and K. R. Rushton (2004). *An International Guide for Hydrogeological Investigations CH4, IHP-VI, SERIES ON GROUNDWATER NO.3*
- MWI (1998): *Groundwater Management Policy*. – In: *WORLD BANK (1999): Groundwater – Legal and Policy Perspectives*, Technical Paper No. 456, 207-218; Washington.
- MWI (2003): *Jordan’ Water Strategy and Policies*. – Ministry of Water and Irrigation, 68 p.; Amman.
- Uil, H., F.C. van Geer, J.C. Gehrels, F.H. Kloosterman (1999), *State of the art on monitoring and assessment of groundwaters*, ISBN 9036952778, Netherlands Institute of Applied Geoscience TNO
- UN/ECE Task Force on Monitoring and Assessment (1999). *Inventory of transboundary groundwaters. Problem-oriented approach and the use of indicators; Application of models; State of the art on monitoring and assessment of groundwaters (four volumes)*. Lelystad, September 1999.
- UN/ECE Task Force on Monitoring and Assessment (1999). *Guidelines on Monitoring and Assessment of Transboundary Groundwaters*, Lelystad, March 2000. ISBN 9036953154.
- UNESCO (1983). *International Legend for Hydrogeological Maps*. Revised edition, UNESCO, Paris.
- UN/ECE (2000), *Guidelines on Monitoring and Assessment of Transboundary Groundwaters*, ISBN 9036953154 (UN/ECE Task Force on Monitoring & Assessment)
- Van Lanen, Henny A.J. (1998), *Monitoring for Groundwater Management in (Semi-) Arid Regions*. UNESCO. ISBN 92-3-103579-7. *Studies and Reports in Hydrology*, 57
- WMO (1994): *Guide to hydrological practices*. Fifth edition. WMO No.168.
- WORLD BANK (1999): *Groundwater: Legal and Policy Perspectives*. – Technical Paper 456, 262 p.; Washington.

**igrac** International Groundwater Resources Assessment Centre

*is an initiative of*

 United Nations Educational, Scientific and Cultural Organization (UNESCO)

 World Meteorological Organization (WMO)

*is sponsored by*

 Government of The Netherlands

*is hosted by*

 Netherlands Institute of Applied Geoscience TNO - National Geological Survey

*For more information contact:*

**IGRAC**

P.O. Box 80015  
3508 TA Utrecht  
The Netherlands

phone: +31 30 256 42 70

fax: +31 30 256 47 55

e-mail: [info@igrac.nl](mailto:info@igrac.nl)

internet: <http://www.igrac.nl>



## Annex A: Groundwater monitoring in different hydrogeological settings

### *Emphasis of groundwater monitoring for different aquifer types*

There is a strong relationship between the aquifer type(s) dominating an area and the possibilities and emphasis of monitoring different components of the groundwater system. Aquifer type, geometry and properties are dominant factors in the overall set-up and efficiency of the monitoring networks and the selection of parameters.

The following descriptions have been partly adopted from *Unesco Studies and reports in Hydrology 57*.

Table A-1, from “*Monitoring for groundwater management in (semi-)arid regions*”, *Unesco: Studies and reports in hydrology 57*, shows the relation between the emphasis of groundwater monitoring and the type of aquifer under consideration.

*Table A1: Priority monitoring variables for different hydrogeological systems*

	Hydrogeological system						
	Unconsolidated			Sedimentary basins		Volcanic	Basement complex
	Alluvial Channel	Alluvial Plains	Dunes	Sandstone	Limestone		
Dominant regime	U,I	U-C,I	U,I	U-C, F-I	U-C,F	SC-C,F	U-SC,F
<b>Variable:</b>							
Groundwater levels	H	H	M	M	H	H	H
Abstraction	H	H	H	L	M	M	H
Springs	L	L	L	M	H	H	L
Evaporative discharge	L	H	M	M	M	L	M
Surface flow	H	H	L	M	H	H	H
Meteorological	M	M	M	M	M	M	H
Soil Moisture	L	M	H	L	L	L	M-L
Network cost	L	M-H	L	M-H	M-L	M	L

Notes: L: low  
M: medium  
H: high

U: unconfined  
SC: semi-confined  
C: confined

F: dominantly fissure flow  
I: dominantly intergranular flow

### ***Groundwater quantity monitoring - Unconsolidated deposits***

Alluvial aquifers are often the most commonly exploited source of groundwater supplies in many regions because of their high permeability, more frequent recharge, accessibility and association with soils suitable for cultivation.

Alluvial groundwater systems can be subdivided into two main types: wadi channels (usually in areas of higher relief), and alluvial plains (mountain front basins formed from coalesced alluvial fan and plain deposits).

#### *Wadi channels.*

Most rivers in arid and semi-arid regions flow only in response to occasional short, intense rainfall events, but are frequently the main source of recharge. Infiltration is governed mainly by the channel and flow characteristics (volume, velocity and duration) and to a lesser extent the depth the channel and flow characteristics (volume, velocity and duration) and to a lesser extent the depth to groundwater. A number of studies have been conducted of transmission losses along wadi systems in representative catchments, such as those carried out in Saudi Arabia (e.g. Abdulrazzak et al., 1989; Sorman & Abdulrazzak, 1993) or in Syria (Khouri, 1982).

#### *Alluvial plains.*

Alluvial plains in arid and semi-arid climates have been studied in many areas of the world, such as south-West USA. They are recharged mainly from runoff draining adjacent high elevation areas. In general, most recharge will occur in the upper part of the plain whilst most abstraction usually takes place in the central part of the plain, often adjacent to the main distributaries. Discharge takes place in sabkhas by shallow groundwater evaporation, evapotranspiration from vegetation around the sabkha zone and in coastal areas by subsurface flow.

Often runoff from rainfall in the high elevation region provides recharge to the low rainfall alluvial plain areas from which discharge occurs subsequently at a coastline or into playas/sabkhas.

Consequently, it is recommended that each major catchment should be treated for water management purposes as a single hydrological unit extending from the main watershed in the mountains to the coast (or internal drainage level).

Monitoring priorities should focus on the data needed for groundwater balance studies, in particular adjacent to active wadi channels where most recharge occurs.

Alluvial plains in zones with moderate or humid climates often contain very productive and intensively exploited aquifers. Networks of observation wells are important for management of the groundwater resources in these areas. Monitoring in the low lands with shallow water tables is often aimed at controlling the delicate balance between exploitation and other groundwater dependent uses (e.g. agriculture, nature, etc.).

#### *Wind-blown sands.*

Wind-blown sands, whilst extensive in arid regions, are usually of limited importance for water supplies. Although the porosity of sand deposits is high, most infiltrating rainfall tends to be retained in the top few metres and lost by evaporation. Recharge studies, undertaken in India, Israel, Saudi Arabia, Tunisia, Botswana and New Mexico show that direct recharge is the dominant mechanism in sand dune areas. Monitoring should focus on meteorological data and soil moisture measurements in conjunction with water level fluctuation data.

### ***Groundwater quantity monitoring - Consolidated sedimentary basins***

Thick and complex sandstone/limestone/shale sequences with varying hydraulic characteristics occur extensively throughout semi-arid zones. These aquifer systems are now being developed increasingly for water supplies, such as in the Middle East and North Africa. Development tends to depend on exploiting storage and on subsurface flow from adjacent areas rather than on vertical recharge as

modern day recharge to these systems may be limited and restricted to the margins of these aquifer systems.

Carbonate sequences in semi-arid zones tend to exhibit less well developed karst features than humid zones. Nonetheless such rocks often have a secondary permeability, associated with widespread small solution channels along bedding planes and joints (e.g. Jordan) or karst-like features associated with the solution of gypsiferous sediments (e.g. Qatar). Recharge through joints and fractures can be an important mechanism in limestone terrains. The recharge characteristics of limestone terrains are described in UNESCO (1984a).

Large springs may arise from carbonate sequences where major fracture systems drain large areas or force groundwater to the surface. Deeply incised wadi systems that have cut below the regional water table can also give rise to significant base flows (e.g. Jordan).

Spring discharges and water level measurements in sinkholes can provide information on the frequency, magnitude and variability of recharge where the catchment area and specific yield are known with reasonable certainty.

The monitoring priorities in sedimentary basins usually relate to their extent and degree of confinement and should focus on the unconfined part of the system and in discharge area. In general, indirect recharge along wadi systems that follow structural zones is usually the dominant recharge mechanism.

Control of the “healthiness” of the groundwater system in these areas may be conducted by regularly monitoring springs and/or baseflow in streams. The resulting data characterize the natural discharge of groundwater from the related groundwater bodies. Groundwater levels in wells may be used as well, but these represent more local values.

Groundwater monitoring along wadis should focus on observing the groundwater levels in wells at increased distance from the active wadi system. Recharge of the adjacent groundwater system by the wadi may be estimated on the basis of the groundwater records and the storage factor of the deposits. Measured or estimated data on use and losses of groundwater (including irrigation) will complete the groundwater balance picture.

#### ***Groundwater quantity monitoring - Volcanic terrains***

Extensive areas of Central India, parts of the Arabia Peninsula, Central South America and the USA and East Africa are covered by thick plateau lavas with a secondary permeability developed from weathering, jointing and fracturing. Layered aquifer systems with numerous small springs may be common (e.g. Yemen). Direct recharge may be restricted by black cotton soils and indirect recharge is often the main recharge mechanism.

Background monitoring priorities are the collection of time-varying data relating to runoff, on spring discharges and on water level fluctuations at different depths.

#### ***Groundwater quantity monitoring - Basement complex***

Basement complex rocks occur extensively throughout semi-arid regions, such as in India and Africa, where they provide local sources of water supply. Limited groundwater supplies are obtained from Basement Complex areas due to their poor aquifer characteristics unless a deep weathered zone, fissuring or alluvial channel deposits are present. More arid areas usually have poor quality water (e.g. Red Sea Hill, Sudan). Typical feature of Basement Complex aquifers are described by Wright & Burgess (1992) or by UNESCO (1984b).

Monitoring priorities should focus on rainfall run-off characteristics where the weathered zone is thin and on factors influencing direct recharge where a thick weathered zone is present.

### **References and related literature**

- Abdulrazzak, M.J.; Sorman, A.U.; Alhames, A.S. 1989. Water balance approach under extreme arid conditions - a case study of Tabalah Basin, Saudi Arabia. *Hydrological Processes* 3: 107-122.
- FAO, 1981. Arid Zone Hydrology. FAO Irrigation and Drainage Paper 37. Rome.
- Gee W.G.; Hillel, D. 1988. Groundwater recharge in arid regions: review and critique of estimation methods. *Hydrological Processes* 2: 255-266.
- Heath, R.C. 1976. Design of groundwater level observation well programmes. *Groundwater* 14(2): 71-77.
- IAHS, 1986. Integrated design of hydrological networks. IAHS Publ. No. 158. Budapest Symposium.
- IAHS, 1990. Groundwater monitoring and management. IAHS Publ. No. 173.
- Khouri, J. 1982. Hydrogeology of the Syrian steppe and adjoining arid areas. *Quart. J. Eng. Geol.* (London) 15: 135-154.
- Lerner, D.N.; Issar, A.I.; Simmers, I. 1990. Groundwater recharge. A guide to understanding and estimating natural recharge. IAH *International Contribution to Hydrogeology*, volume 8. Hanover.
- Made, J.W. van der (ed.) 1986. Design aspects of hydrological networks. TNO Committee on Hydrological Research, The Hague.
- Nielsen, D.M. 1991. *Practical handbook of groundwater monitoring*. Lewis (Publ.), USA.
- Schulze, R.E. 1984. Regional potential evaporation mapping in areas with sparse climatic data. Proc. Symp. in Reg. Hydrol. 25<sup>th</sup> Intern. Congress, Freiburg.
- Sorman, A.U.; Abdulrazzak, M.J. 1993. Infiltration-recharge through wadi beds in arid regions. *Hydrological Sciences* 38(3); 173-186.
- UNESCO 1972. Groundwater studies. An international guide for research and practice. Paris.
- UNESCO 1984a. Guide to the hydrology of carbonate rocks. *Studies and reports in hydrology* 41. Paris.
- UNESCO 1984b. Groundwater in hard rocks. *Studies and reports in hydrology* 33. Paris.
- UNESCO/WMO 1988. Water resource assessment activities. Handbook for National Evaluation.
- UNESCO 1998. Monitoring for groundwater management in (semi-)arid regions. *Studies and reports in hydrology* 57. Paris.
- WMO 1972. Casebook on hydrological network design practice. WMO Publ. No. 324. Geneva.
- WMO 1981. Guide to hydrological Practices. WMO Publ. No. 168. Geneva.
- WMO 1982. Concepts and techniques in hydrological network design. Operational Hydrology Report No. 19. Geneva.
- WMO 1989. Management of Groundwater observation programmes. Operational Hydrology Report No. 19. Geneva.
- WMO 1989. Management of groundwater observation programmes. Operational Hydrology Report 31. Geneva.
- Wright, E.; Burgess, W. (eds.) 1992. The hydrogeology of crystalline basement aquifers in Africa. *Geological Society of London Special Publication* No. 66.

## **Annex B: Selection and installation of wells for groundwater monitoring**

### **B.1 Introduction**

Selection and installation of wells for groundwater monitoring are follow-up activities of the analysis of the groundwater system (chapter 4) and a documented groundwater monitoring plan as described in chapters 6, 7 and 8 of the guideline. The monitoring plan contains the map(s) that show(s) selected existing wells as well as the potential locations for new wells. Based on the monitoring plan and the basic information further implementation of the monitoring network can be scheduled.

In the initial stage of a monitoring programme different types of existing wells, including dug wells, tube wells and boreholes (hard rock) may be used. Abandoned wells may be considered only if these meet the specified criteria. Existing wells selected from the well inventory, may have to be revisited for detailed analysis and description, cleaning and repairs, and for reaching an agreement with the owner about access to the well, the frequency of observation or sampling, etc. Such field surveys have to be properly planned.

Since installation of new wells is usually very costly, multiple use of the new wells is often considered. In order to accommodate both water level measurements and groundwater quality sampling, the diameter of the observation well needs to be sufficient to let standard well sampling devices pass. If wells are to be used for water supply as well, the length and diameter of screen and the diameter of the standpipe will have to be increased to enable the required production and to accommodate the pump.

Annex B contains a collection of information from different sources, such as ACSAD-BGR (2004). Text from that guide has been included with permission of the author.

### **B.2 Selection of existing wells for groundwater monitoring**

#### **B.2.1 Formulation of criteria for selection of existing wells**

Several types of wells can be available for groundwater monitoring:

- Monitoring wells (wells with single or multiple piezometres);
- Water supply wells (tube wells or dug wells used for domestic, municipal, agricultural or industrial water supply)

For a systematic selection of monitoring wells out of the available wells it is essential to define selection criteria. This should be done by an experienced groundwater professional. Criteria considered essential are listed below:

- The well is a target location (fitting in the monitoring plan);
- The location is representative for the monitoring objectives aimed at. It should not be too close to activities that may disturb the monitoring purpose, such as pumping wells with direct influence on the water level recording or local sources of groundwater pollution that may disturb the regional image of groundwater quality.
- Essential data about the well are known or verifiable; (depth, diameter, screen depth, etc.);

- Description of the lithology (a lithological log of the well) is available for interpretation of the hydrogeological unit penetrated by the well screen section;
- The well screen should penetrate only one (major) aquifer and not several;
- If an observation well has several piezometres, the screens should be strictly separated by proper plugging.
- The well is clean and representative for water level fluctuations;
- The well is clean and suited for groundwater quality sampling;
- The well is accessible for observers in all seasons;
- The well is reasonably protected from vandalism or potential damage;
- If a pumping well is planned to be used for groundwater level measurement, there has to be agreement with the owner to stop pumping during a sufficiently long recovery period for representative measurements. The length of that period depends on the recovery of the well and should be determined by the hydrogeologist on the basis of a recovery test or on the basis of experience with similar conditions.

Some criteria are less critical than other ones. For instance, availability of a lithological log or description is not a hard criterion for relatively shallow wells, as long as the hydrogeologist knows with reasonable certainty which hydrogeological layer is penetrated/tapped by the well. Availability of historical records on water quality or water quantity (water levels) is considered important but not a hard criterion for selection. However, availability of a record may be a reason to give priority to a well above its neighbour wells if other conditions are comparable.

### **B.2.2 Preliminary selection of wells in the office**

The design of the monitoring programme and the preliminary selection of monitoring wells are usually based on information collected during the inventory of available wells. A preliminary selection may be made in the office and may result in lists or maps showing a first and second choice of wells. However, the suitability of the wells for monitoring will have to be decided on the basis of the list of technical and logistical selection criteria defined, which will very often require extra field surveys for verification of the conditions in the field. Availability of a historical record may be considered an important reason to select a well from a cluster of wells if other conditions are similar.

#### *Warning regarding abandoned wells!*

Abandoned abstraction wells should generally be disregarded for groundwater monitoring purposes. The most important reason is that their functionality is mostly not guaranteed. On the contrary, their lacking functionality is often the reason for them being abandoned. A monitoring program should not create data of questionable value for that would undermine the overall acceptance. However, if abstraction wells have been abandoned because production was no longer necessary, they may be checked and used, provided that all important conditions are fulfilled.

### **B.2.3 Verification of conditions in the field and final selection**

In order to verify the definite suitability of wells for groundwater monitoring a field survey will often be necessary. Such a visit may have different purposes:

- To check the information on relevant conditions that have led to selection of the well;
- To gather missing information on the well and its location for completion of the monitoring station file (see also Annex E);
- To select the most suitable well for monitoring from a cluster of wells;
- To contact the owner about necessary agreement on the frequency of sampling or observation, possible compensation, etc;
- To verify whether other limiting conditions may be in the way of monitoring. For instance, built in submersible pumps, may exclude the well from proper groundwater level measurements.

Where wells do not satisfy the criteria alternative wells or locations may have to be considered. Hence, the field survey may also be used to visit places where gaps in the coverage of monitoring wells occur or where new wells may have to be installed.

In preparation of the field survey field maps indicating the sites to be visited should be drawn. Because some wells from the preliminary selection may drop out, information on neighbouring wells may be needed as well.

The above activities will end up in a definite selection of monitoring well locations. Selected monitoring wells should be unmistakably marked in the field. A complete set of data should be collected from each groundwater monitoring well and a data file should be kept in the office (see also Annex E of the guideline). It is recommended to include a sketch and photos of the site to facilitate retrieval of the location.

#### **B.2.4 Rehabilitation of selected (monitoring) wells**

Before including monitoring wells into a monitoring network there may be a need for rehabilitation, especially if they are not clean or need repairs. In many published documents rehabilitation refers to restoration of production wells, focusing mainly on improvement of production. However a high production is not needed for successful groundwater level monitoring or groundwater sampling. As long as wells are still in use for water supply, a reasonable contact with the groundwater in the aquifers is often guaranteed and cleaning may not be necessary.

Rehabilitation of a well for monitoring purposes has physical, chemical and biological aspects. Some common activities are: the removal of sediment, restoration of the hydraulic contact with the aquifer by flushing the well, restoration of the surface seal and/or protective cover. Rehabilitation of small diameter observation wells or piezometres requires utilisation of special small size equipment and careful and time consuming treatment. For instance, removal of sediments may be done by either bailing the sediments out or by removal through pumping or air lifting. If a method of pumping is used to clean the monitoring well, the production of the pump has to be adjusted to the (decreased) capacity of the well, also taking into account the strength of the tube and screen materials. Using a (too) high pumping or air lifting capacity may easily lead to implosion of the well or its screen, especially if the construction material of the monitoring well is relatively weak (see also chapter B6).

The American Society of Testing Materials (ASTM) prepared a standard *on maintenance and rehabilitation of monitoring wells, numbered D 5978-96*.

About ASTM standard D 5978-96:

This guide covers an approach to selecting and implementing a well maintenance and rehabilitation program for groundwater monitoring wells. It provides information on symptoms of problems or deficiencies that indicate the need for maintenance and rehabilitation. It is limited to monitoring wells, that are designed and operated to provide access to, representative water samples from, and information about the hydraulic properties of the saturated subsurface while minimizing impact on the monitored zone. Some methods described herein may apply to other types of wells although the range of maintenance and rehabilitation treatment methods suitable for monitoring wells is more restricted than for other types of wells. Monitoring wells include their associated pumps and surface equipment.

This guide is affected by governmental regulations and by site specific geological, hydrogeological, geochemical, climatological, and biological conditions.

The success of rehabilitation programmes may be uncertain as concluded by one of the contributors to the above standard:

*“In practice however it seems almost toothless because virtually no chemicals or even air can be used to rehabilitate fouled monitoring wells. There is only redevelopment, which rarely provides excellent results by itself. The only hope for long-term valid monitoring well results is good design and development in the first place. This is firmly established doctrine.”*



If selected wells do not meet the essential criteria, even after a rehabilitation programme has been conducted, the wells should be excluded from the monitoring programme!

### B.3 Site selection procedure for new monitoring wells

New monitoring wells may be needed at locations indicated by the groundwater monitoring network plan, if no suitable existing wells are available or if these do not satisfy the conditions required. A site selection procedure is then necessary to determine the most suitable well sites.

#### B.3.1 Formulation of site selection criteria

A set of site-selection criteria will be needed for selecting suitable locations. The criteria may cover technical as well as ownership and logistic aspects. Examples of such criteria are given below:

- The site is a target location, fitting well enough in the monitoring programme plan;
- The site is representative for the (regional) monitoring objectives of the reference network. As far as groundwater level monitoring is concerned the well site should be free from local impacts. There should be no disturbing impacts from production wells, such as fluctuations induced by the pumping regime. Also rapid fluctuations caused by irrigation return flows, etc. should not be measured. So, the well should be located at a safe distance from such activities. As far as groundwater quality monitoring is concerned possible impacts (micro trends) from local sources of pollution should be avoided;
- Installing the well does not cause damage to environmentally sensitive sites;
- The ownership of the site is clear and the owner is ready for agreement with respect to drilling a new monitoring well and for continued monitoring;
- The site is accessible for observers in all seasons and can be reasonably safeguarded against vandalism;
- The site is accessible for the rig and the support vehicles;
- Adequate space is available at the site for setting up drilling equipment, digging mud pit and draining the discharge. The site should be clear of trees, overhead electric cables, under ground cables/ pipelines/ drainage lines, etc.

Remark: Local impacts on either groundwater levels or groundwater quality may be monitored in local or specific networks for the purpose of detailed studies. another setting.

#### B.3.2 Investigation of the target areas and selection of new well sites

Investigating potentially suitable locations may start with a desk-study. Information needed includes topographic maps, hydrogeological maps and cross sections, water level maps, water quality contour maps, iso-pach maps, vulnerability maps, etc.

On the basis of the information a map should be prepared showing target areas for installation of new monitoring wells. This may be done by drawing circles on the map, indicating the outer boundaries of the area where a well site should be found. The information brought to the field should also include the required monitoring function(s) of the wells and the relevant criteria, which may be different for each monitoring function.

The information available and the criteria listed serve to check which location(s) can be considered suitable sites for new monitoring wells. However, in some cases originally planned locations may have to be abandoned because of practical problems such as unwillingness of the owner, inaccessibility of the area for drilling equipment and/or observers, vulnerability of the area to vandalism, etc. In such case the professional involved in design of the monitoring plan should be consulted for an alternative location.

Selected well sites should be clearly indicated on the map as well as in the field. The groundwater professional involved in the selection should also indicate the exact location to the drilling crew.

## B.4 Design of monitoring wells

The result of the well design process should be a document containing all necessary practical information) needed for drilling and installation of the new well (expected depth, expected lithology, borehole and well specifications, etc). For selection of drilling methods, well material and filter packs see section **Error! Reference source not found.**).

ASTM developed a “Standard Practice for Design and Installation of Ground Water Monitoring Wells in Aquifers (2002)” which provides useful technical information for well design. Also the “Handbook of Suggested Practices for the Design and Installation of Ground-Water Monitoring Wells” (Aller, L., et al. 1991) is suggested for further reading.

Apart from the guidance found in handbooks the following general considerations may be useful:

- The design of a monitoring well depends on the required monitoring function(s) of the well (see Chapters 6 and 7 of the Guideline) and whether it will be used for water supply if the hydrogeological conditions are favourable. These requirements have implications for the number of piezometres to be installed, the depth, length and size of screens and tubes and consequently for the diameter of the borehole. Especially if the borehole is to be converted into a water supply the design will have to be considerably different.
- The well design should be based on the available information with respect to successive hydrogeological units as indicated by the conceptual model. All available geological and geophysical information should be used.
- The lithological borehole description based on rock sampling can often be significantly improved if geophysical borehole logging is applied. Especially if rotary drilling methods are applied and materials tend to get to the surface in a mixed and delayed way. The geophysical borehole logs may provide much better indications with respect to the depth of different layers and their permeability.
- The diameter of a monitoring well depends on the sampling devices available. A diameter of 2 inch for tube and screen is considered a minimum for water quality sampling if small size equipment is available. In many countries a diameter of 4 inches is preferred. A larger diameter will also be necessary for wells that will be used for water supply as well.
- Screens must be positioned on the right depths, confronting the aquifer layers. The packing material around the screens should be of the proper size and form a suitable transition zone between aquifer material and slot size of the screen(s). This also applies to monitoring wells. The slot size of the screen(s) should be designed in such a way that packing material cannot enter the well and only very minor portions of the aquifer material can pass.
- Inflow of surface water into a monitoring well, either directly into the well or via the borehole and packing material should be avoided. Proper plugging of the borehole around the well with clay or bentonite is essential in the upper section above the screen. This also applies to sections between screens if more than one piezometres are installed. These plugs should be installed at the depth of less permeable layers above or between the aquifers.

## B.5 Drilling, installation and completion of monitoring wells

### B.5.1 Drilling

Drilling and installation of monitoring wells should follow (international) acknowledged practices. The most suitable drilling method for (monitoring) wells depends on the rock types expected and the well function(s) required. However, in practice, the decision about the drilling method to be used is determined by the availability of drilling equipment and drilling experience as well (see B5).

A detailed list of drilling methods, together with examples of applications, advantages and limitations of each the methods is given by EPA, see Table B1. A detailed table is given in Appendix A.

Concerning the applicability of the drilling methods DVGW (2001) proposes the following techniques for drilling of monitoring wells:

*Unconsolidated rocks:* All Rotary drilling methods; cable-tool drilling; driven wells (rammed filters or direct-push wells);

*Consolidated rocks:* Direct-Rotary drilling; cable-tool drilling; down-the-hole hammering.

Further reading concerning drilling methods and their (dis-)advantages: Kovalevsky, 2004 (pages 185-215); Lapham, 1997 (see for instance table 15 and 16).

To enable proper installation the diameter of the borehole will have to be at least 2 inches more than the diameter of the well to be installed. For a single observation well the borehole diameter may be relatively small, e.g. 4 to 5 inches. A larger borehole is needed if more than one piezometres will be installed in the same borehole or if a production well will be installed.

Drilling a small diameter exploratory borehole (for instance a pilot/test hole of 4 inches) may be recommendable, especially if there is no certainty about the existence of significant aquifers at the planned well site. The exploratory borehole should be drilled to the full depth of the planned well or deeper. The borehole will provide the necessary lithological and hydrogeological information to be used for further well design (depth end length of screens, packing materials, etc.), and for decisions regarding possible reaming of the borehole for installation of a production well. Such information is essential to avoid risks of unnecessary investments in drilling. Especially rotary drilling methods lend themselves very well for drilling such pilot holes and subsequent reaming, because of the flexibility in drilling with different types and sizes of bits.

### **B.5.2 Well installation**

It must be ensured that the monitoring well is correctly recording the water table or the hydraulic head at the specified depth. Therefore, the well will have to be properly installed and developed. Checks include the tightness of its casing (e.g. the positions and tightness of the annular sealants). Rehabilitation of monitoring well may be required after a certain time. Therefore, the functionality of the monitoring well should be checked at regular intervals.

The *well casing and screen material* should meet the specified requirements. Requirements listed by EPA may be used as reference (EPA, 1994):

- The materials should maintain their structural integrity and durability in the environment in which they are used over the entire operating lifetime;
- They should be resistant to chemical and microbiological corrosion and degradation in contaminated and uncontaminated waters;
- They should be able to withstand the physical forces acting upon them during and following their installation, and during their use;
- They should not chemically alter groundwater samples;
- They should be easy to install during the construction of a monitoring well and the material itself or its stability (tensile strength, compressive strength, and collapse strength) should not alter after installation.

The *filter packs* need to be put in place in such a way that there is no segregation of materials and that the projected top and bottom depths are maintained. At greater depths the use of prepacked filters is recommended, because only this way it is sufficiently ensured that the filter pack is properly located.

The used filter pack material must be bacteriologically safe and during installation any bacteriological or other contamination must be avoided. The chosen gravel pack size depends on the aquifer material (sieve analysis results) and influences the screen slot size.

Top and bottom formation seals must be properly installed in order to avoid water reaching the casing through leaking annular sealants. Centralizers should be installed at proper distances so that the proper functioning of seals and gravel packs is guaranteed.

### B.5.3 Well completion

This section contains some practical suggestions to complete the well installation.

- Make sure that the outside surface of the piezometre tube, including the joints, is as smooth as possible to ease its installation;
- Use centralizers to keep (non-prepacked) screens in the centre of the borehole.
- Make sure that the inside surface of the piezometre tube is as smooth as possible to avoid that measuring equipment may get stuck.
- In case of several piezometres in one borehole, the top of the piezometres above surface level should be indicative for the depth of their screen (the deeper a piezometre, the lower its top). The tubes of piezometres may be cut at heights differing by 5 cm, for instance.
- Do not use a screw-top to close a tube.
- Give each tube a unique number and place a unique identification label on the monitoring well.
- Construct a cement surface seal above surface level for stability and to prevent from surface water entering the well directly.
- A steel casing will protect from vandalism and water entering the well.
- Fix a lock to prevent unauthorized access to the well, if necessary in combination with a fence around the monitoring well.

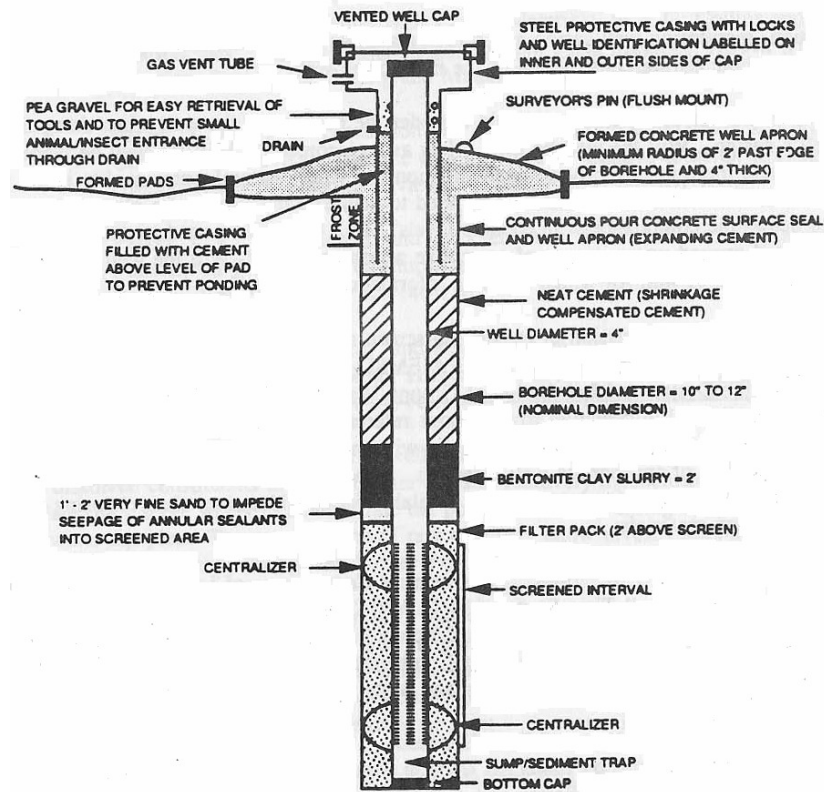

Figure 0.1: Design Diagram of a Typical Groundwater Monitoring Well (from EPA 1994)

## B.6 Cleaning and development of monitoring wells.

For the purpose of groundwater monitoring, cleaning and development is needed to ensure a proper hydraulic contact between the well and the aquifer environment. Monitoring the water level in the well should be representative for the hydrologic regime in the aquifer. In a similar way groundwater quality samples taken from the well should represent the groundwater quality in the surrounding aquifer. The aim of well development is to test the required functionality of the monitoring well.

Well cleaning and development can be regarded as one of the most crucial elements of well installation, especially if rotary drilling has been applied. Cleaning and development should be conducted soon after well completion: preferably not later than one week and not earlier than one day after completion. It should be conducted by experienced personnel with carefully selected equipment.

It should be stressed that monitoring of groundwater levels (and groundwater quality) requires a good hydraulic contact between the well and the corresponding aquifer(s). However, *a high groundwater production is not needed* for the purpose of monitoring alone.

**Warning.** Cleaning and development of the monitoring well should be conducted with utmost care, especially when the screen size (length and diameter) is small and screen and tube material are of a vulnerable type. A too aggressive development method may easily damage the well (screen and/or tube), cause deformations of the filter pack or unwanted leaks through seals or leaky joints and cause the well to be useless for further monitoring.

Therefore, the monitoring well should be exposed to a gradual cleaning and development procedure with flexible, small capacity equipment (a small compressor for air lifting or a small capacity pump). As soon as the well starts discharging water the airlifting or pumping capacity can be slowly increased. However, the withdrawal of water should never exceed the estimated capacity of the monitoring well. One should always keep in mind the often limited production capacity of monitoring wells!

If the well is to be used for water supply as well, the purpose of cleaning and development is to optimize the yield of the well. In that case the size of the well tube and screen usually allow for higher production during pumping and a more rigorous development method.

A number of factors have to be considered for selection of the appropriate cleaning and development method. These are

- The construction of the well (monitoring and or water supply) and the materials used (especially screen size and material);
- The drilling method applied: especially if boreholes have been drilled by rotary machines using high viscosity mud to lift the cuttings, extensive well cleaning may be needed.
- The lithological composition of the aquifer and its expected hydraulic properties: which yield of water may be expected;
- The depth of the static water level and the estimated depth to water for pumping or air lifting methods;
- Possible constituents introduced into the well and aquifer during drilling (relevant for groundwater quality sampling).

The following methods may be used for well development:

- Mechanical surging;
- Air lift pumping;
- Pumping and backwashing;
- High-velocity hydraulic jetting;
- High-velocity hydraulic jetting combined with simultaneous pumping.

As stated before soft methods are preferred above aggressive methods. Jetting methods may be tested on a spare piece of screen material before applying it to the well itself.

For the purpose of groundwater quality monitoring the well should be clean of all constituents that do not represent the natural environment of the aquifer. The well development equipment needs to be decontaminated and free of any substances which may have impact on the water quality or the constituents to be analyzed, in order to avoid or minimize the effects of bacteriological or other contaminations.

A well development report has to be completed after termination of development. Details are documented, for instance, in ASTM standard D 5521 (1994).

Table B1

<b>Driven Wells</b>	
<i>Applications and Advantages</i>	<i>Limitations</i>
<ul style="list-style-type: none"> <li>- Water level monitoring in shallow formations</li> <li>- Ease of water samples collection</li> <li>- Low cost, encouraging the installation of a larger number of monitoring facilities</li> </ul>	<ul style="list-style-type: none"> <li>- Depth limited to approx. 15 m</li> <li>- Small diameter casing</li> <li>- No soil sample recovery, i.e. no lithological interpretation possible</li> <li>- Steel casing may interfere with some hydrochemical constituents</li> <li>- Lack of stratigraphic details creates uncertainty regarding screened zones and/or cross-contamination</li> <li>- Cannot penetrate dense and/or some dry materials</li> <li>- No annular space for well completion</li> </ul>
<b>Solid-Stem Auger Drilling</b>	
<i>Applications and Advantages</i>	<i>Limitations</i>
<ul style="list-style-type: none"> <li>- Shallow soil investigations</li> <li>- Soil sampling</li> <li>- Vadose zone monitoring wells</li> <li>- Monitoring wells in saturated, stable soils</li> <li>- Identification of depth to bedrock</li> <li>- Fast and mobile</li> </ul>	<ul style="list-style-type: none"> <li>- Unacceptable soil samples, unless split-spoon or thin-wall samples are taken</li> <li>- Soil sample data limited to areas and depths where stable soils are predominant</li> <li>- Unable to install monitoring wells in most unconsolidated aquifers because of borehole caving upon auger removal</li> <li>- Depth capability decreases as diameter of auger increases</li> </ul>
<b>Hollow-Stem Auger Drilling</b>	
<i>Applications and Advantages</i>	<i>Limitations</i>
<ul style="list-style-type: none"> <li>- All types of soil investigations</li> <li>- Permits good soil sampling with split-spoon or thin-wall samplers</li> <li>- Water quality sampling</li> <li>- Monitoring well installation in all unconsolidated formations</li> <li>- Can serve as temporary casing for coring rock</li> <li>- Can be used in stable formations to set surface casing</li> </ul>	<ul style="list-style-type: none"> <li>- Difficulty in preserving sample integrity in heaving formations</li> <li>- Formation invasion by water or drilling mud if used to control heaving</li> <li>- Possible cross-contamination of aquifers where annular space not positively controlled by water or drilling mud or surface casing</li> <li>- Limited diameter of augers limits casing size</li> <li>- Smearing of clays may seal off aquifer to be monitored</li> </ul>
<b>Mud Rotary Drilling</b>	
<i>Applications and Advantages</i>	<i>Limitations</i>
<ul style="list-style-type: none"> <li>- Rapid drilling of clay, silt and reasonably compacted sand and gravel formations</li> <li>- Allows split-spoon and thin-wall sampling in unconsolidated materials</li> <li>- Allows core sampling in unconsolidated formations</li> <li>- Abundant and flexible range of drilling tool sizes and depth capabilities</li> <li>- Very sophisticated drilling and mud programs available</li> <li>- Ease of geophysical borehole logging</li> </ul>	<ul style="list-style-type: none"> <li>- Difficult to remove drilling mud and wall cake from outer perimeter of filter pack during development</li> <li>- Bentonite or other drilling fluid additives may influence quality of groundwater samples</li> <li>- Circulated (ditch) samples poor for monitoring well screen selection</li> <li>- Split-spoon and thin-wall samplers are expensive and of questionable cost effectiveness at depths greater than 50 m</li> <li>- Wireline coring techniques for sampling both unconsolidated and consolidated formations often not locally available</li> <li>- Difficult to identify aquifers</li> <li>- Drilling fluid invasion at permeable zones may compromise validity of subsequent monitoring well samples</li> </ul>



<b>Air Rotary Drilling</b>	
<i>Applications and Advantages</i>	<i>Limitations</i>
<ul style="list-style-type: none"> <li>- Rapid drilling of semi-consolidated and consolidated rock formations</li> <li>- Good quality reliable formation samples</li> <li>- Allows easy and quick identification of lithologic changes</li> <li>- Allows identification of most water-bearing zones</li> <li>- Allows estimate of yields in strong water producing zones with short down-time</li> </ul>	<ul style="list-style-type: none"> <li>- Surface casing frequently required to protect top of hole</li> <li>- Drilling restricted to semi-consolidated and consolidated formations</li> <li>- Samples occur as small particles that are difficult to interpret</li> <li>- Drying effect of air may mask lower-yield water-producing zones, allowing only identification of significant water-bearing zones</li> <li>- Air stream requires contaminant filtration</li> <li>- Air may modify chemical or biological conditions and recovery time is uncertain</li> </ul>
<b>Air Rotary with Casing Driver Drilling</b>	
<i>Applications and Advantages</i>	<i>Limitations</i>
<ul style="list-style-type: none"> <li>- Rapid drilling of unconsolidated clays, silts and sands</li> <li>- Drilling in alluvial material</li> <li>- Casing supports borehole thereby maintaining borehole integrity and minimizing inter-aquifer cross-contamination</li> <li>- Eliminates circulation problems common with direct-mud rotary drilling</li> <li>- Good formation sample recovery</li> <li>- Minimal formation damage when pulling back casing</li> </ul>	<ul style="list-style-type: none"> <li>- Thin, low-pressure water-bearing zones easily overlooked if drilling not stopped at appropriate places to observe whether or not water levels are recovering</li> <li>- Difficult interpretation of rock samples due to pulverization</li> <li>- Air may modify chemical or biological conditions and recovery time is uncertain</li> </ul>
<b>Dual-Wall Reverse-Circulation Rotary Drilling</b>	
<i>Applications and Advantages</i>	<i>Limitations</i>
<ul style="list-style-type: none"> <li>- Very rapid drilling through both unconsolidated and consolidated formations</li> <li>- Allows continuous lithological sampling in all types of formations</li> <li>- Very good representative lithological samples can be obtained with minimal risk of contamination of sample and/or water-bearing zone</li> <li>- In stable formations, wells with diameters as large as 6 inches can be installed in open-hole completions</li> </ul>	<ul style="list-style-type: none"> <li>- Limited borehole size that limits diameter of monitoring wells</li> <li>- In unstable formations, well diameters are limited to approx. 4 inches</li> <li>- Air may modify chemical or biological conditions and recovery time is uncertain</li> <li>- Unable to install filter pack unless completed as open hole</li> </ul>
<b>Jet Percussion Drilling</b>	
<i>Applications and Advantages</i>	<i>Limitations</i>
<ul style="list-style-type: none"> <li>- Allows water level measurement</li> <li>- Sample collection in form of cuttings</li> <li>- Primary use in unconsolidated formations, but may be used in some softer consolidated rock formations</li> <li>- Best application is 4-inch borehole with 2-inch casing and screen installation</li> </ul>	<ul style="list-style-type: none"> <li>- Drilling mud may be needed to return cutting to surface</li> <li>- Diameter limited to 4 inches</li> <li>- Installation slow in dense, bouldery clay/till or similar formations</li> <li>- Disturbance of the formation possible if borehole not immediately cased</li> </ul>
<b>Cable Tool Drilling</b>	
<i>Applications and Advantages</i>	<i>Limitations</i>
<ul style="list-style-type: none"> <li>- Drilling in all types of geologic formations</li> <li>- Almost any depth and diameter range</li> <li>- Ease of monitoring well installation</li> <li>- Ease and practicality of well development</li> <li>- Excellent samples of coarse-grained materials</li> </ul>	<ul style="list-style-type: none"> <li>- Slow drilling advancement</li> <li>- Heaving of unconsolidated materials must be controlled</li> </ul>

## B.7 References and additional reading

- ACSAD-BGR, 2004, Management, Protection and Sustainable Use of Groundwater and Soil Resources in the Arab Region, Volume 7 of Guideline for Groundwater Monitoring
- Aller, L., et al. 1991. Handbook of Suggested Practices for the Design and Installation of Ground-Water Monitoring Wells. EPA/600/4-89/034 (NTIS PB90-159807), 221 pp. Also published in 1989 by National Water Well Association, Dublin, OH in its NWWA/EPA series, 39800. [Nielsen and Schalla (1991) contain a more up-dated version of material in this handbook that is related to design and installation of ground-water monitoring wells].
- ASTM (1999): Ground Water and Vadose Zone Investigations: Drilling, Sampling, Geophysical Logging, Well Installation and Decommissioning. – 2nd edition, 576 p.; West Conshohocken/PE/USA.
- ASTM (2002): Standard Practice for Design and Installation of Ground Water Monitoring Wells in Aquifers. – American Society for Testing and Materials, Standard D5092-02, 14 p.; West Conshohocken/PE/USA.
- ASTM (2002), Standard Guide for Selection and Documentation of Existing Wells for Use in Environmental Site Characterization and Monitoring, reference: D5980-96e1
- ASTM (2005), Standard Guide for Maintenance and Rehabilitation of Ground-Water Monitoring Wells (D 5978-96).
- EPA (1994), RCRA Ground Water Monitoring – Draft Technical Guidance. – 220 p.; Rockville/USA (Gov.Inst.Inc.).
- Hydrology Project (2003), Field Manual Hydrological Information System, Volume 4 – Part I, Network design and site selection
- Hydrology Project (2003), Field Manual Hydrological Information System, Volume 4 – Part II, Drilling of lithospecific piezometer
- Kovalevsky, V., G. Kruseman and K. Rushton (eds.), 2004, Groundwater studies. An international guide for hydrogeological investigations, Series IHP Groundwater Series, (pag 199-214)
- Lapham, Wayne W. and Francesca D. Wilde, and Michael T. Koterba (1995), Ground-Water Data-Collection Protocols and Procedures for the National Water-Quality Assessment Program: Selection, Installation, and Documentation of Wells, and Collection of Related Data, USGS open-file report 95-398 (download from: <http://water.usgs.gov/nawqa/OFR95-399.html>)
- Lapham, Wayne W., Francesca D. Wilde, and Michael T. Koterba (1997), Guidelines and standard procedures for studies of ground-water quality: selection and installation of wells, and supporting documentation, USGS water-resources investigations report 96-4233, <http://water.usgs.gov/owq/pubs/wri/wri964233/>
- Nielsen, D. M. and R. Schalla. 1991. Design and Installation of Ground Water Monitoring Wells. In: David M. Nielsen (editor), Practical Handbook of Ground-Water Monitoring. Lewis Publishers, Inc.
- SHUTER, E. & TEASDALE, W.E. (1989): Techniques of Water Resources Investigation, Chapter F1: Application of Drilling, Coring and Sampling Techniques to test Holes and Wells (in short: TWRI 2 - F1).
- Smith, S.A. 1995. Monitoring and Remediation Wells: Problem Prevention, Maintenance and Rehabilitation, CRC Lewis Press, Boca Raton, FL.
- USACE (2001) : Operational Guidelines for Humanitarian Civic Assistance Water Well Drilling

### Other sources:

- IGRAC manages an online database on ‘Guidelines and Protocols for groundwater data acquisition’ which shows a rather detailed list of available documents including references where to obtain them (see also: [http://igrac.nitg.tno.nl/gpm\\_database.html](http://igrac.nitg.tno.nl/gpm_database.html)).

## **Annex C: Water level recording and discharge measurements**

### ***C1 Scope of annex C***

Annex C describes how to conduct representative measurements of groundwater levels and groundwater discharge in different hydrogeological settings and under different conditions of natural groundwater flow and exploitation. Low, medium and high cost methods are considered. The annex describes the properties and applicability of instruments for piezometric monitoring as well as for discharge measurements. Different types of monitoring points, including wells, piezometers, horizontal galleries, channels, natural streams (base flow) and springs are considered.

This annex purposely focuses on methods and devices applied for measuring groundwater levels (or piezometric data) and groundwater discharge from springs and streams (base flow), since these are the only groundwater related data that can be measured directly. These data only constitute a part of the data and parameter needed to calculate the complete groundwater balance or to analyse the dynamic behaviour of the groundwater system. All other components of groundwater quantity (several components of natural and artificial recharge and losses) are determined in a more indirect way, requiring different data sources with their own specific monitoring method(s). Discussing these methods and data sources is considered to be too far from the purpose of this guideline.

## **C2 Piezometric measurements and recording**

In this annex all points where groundwater can be observed are considered potential piezometric points. So piezometric points may include observation wells and piezometers, but also pumped wells, springs and streams discharging groundwater (UNESCO, 2000).

### **C2.1 Monitoring in different aquifer types**

#### ***Hard rock versus unconsolidated sediments***

From a theoretical point of view, there is no difference in groundwater level monitoring between complex groundwater flow systems of consolidated, hard or karstic aquifers (where flow is entirely or partly linked to the occurrence of joints, fractures and/or voids) and groundwater flow systems in unconsolidated sediments (where flow takes place predominantly in the intergranular porous space) (UN/ECE, 1999). However, in practice defining the geometry of the aquifer system, selecting suitable well locations for monitoring wells and drilling boreholes in hard rock is often much more difficult than in unconsolidated sediments. It may require additional information and involve a higher level of expenses.

#### ***Heterogeneous or anisotropic formations***

Groundwater flow directions are determined on the basis of groundwater level data. Boreholes or wells screened in the same hydrostratigraphic unit are necessary for this purpose (USEPA, 1991). In heterogeneous aquifers, in which hydrogeological parameters vary with location and depth, the position of screens must be carefully selected in order to avoid that piezometers belong to different hydrostratigraphic units.

The water level measured in a borehole is a function of the hydraulic head acting at the screened or permeable section of the borehole; the screen should be as short as possible (USEPA, 1992) recommends, with some exception, that the screens be less than 3 m long. In fact, the water level measured with a long screen is a function of the head distribution over the entire length of the screen. For the interpretation of water level measurements in piezometers with long screen intervals and where the water level is considerably different along the screened interval this fact needs to be taken in consideration.

In case the vertical component of groundwater flow is not negligible or where there is a significant heterogeneity and/or anisotropy the monitoring should be based, at least in part, on data from multiple piezometers. Two solutions are traditionally used (UNESCO, 2004):

- clusters of small-diameter piezometers placed in a large borehole with their screens at different depths. The screens are vertically isolated from one another by clay or other impervious material;
- clusters of piezometers in separate boreholes drilled to different depths, with a screened section at the bottom of each piezometer (This solution is simpler but usually more expensive).

The first implementation step of a monitoring system is often based on the use of existing wells. In such case, the minimum required conditions should be availability of well construction data and lithological descriptions of penetrated rock at the location of the selected well and secondly absence of affects of pumped wells in the close surrounding of the monitored wells.

#### ***Artesian aquifers***

A casing extension is useful in the case of artesian boreholes where the maximum piezometric level is about less than 2 m above the ground surface. The casing extension may consist of a simple tubular extension of the borehole casing, preferably with a small diameter (e.g. 2 inches). As an alternative, a transparent marked extension can be used. It is important that the connection between the extension

pipe and the well casing is water tight which usually requires sealing. It will be necessary to wait with measurement till the water level in the extension pipe has become stable.

If the piezometric level surpasses a height of some metres above ground surface a pressure device will usually be necessary. A good mercury manometer can measure pressure equal to tens of meters of water column with an accuracy of 0.03 m. A pressure gauge is less sensitive and accurate.

## C2.2 Use of production wells for groundwater level measurement

Groundwater measurements in wells should be representative for the actual regional state of groundwater in the aquifer. If production wells are utilized as piezometric points the drawdown cone caused by pumping usually is a disturbing factor. Therefore, groundwater level measurements should preferably be taken after the pumping has been stopped and recovery of the groundwater levels can be considered nearly complete.

The length of the recovery period depends on the formation characteristics and, in case of semi-confined aquifers with delayed yield on the pumping rate and duration as well. The recovery period may range from some minutes to hours or days. In practice, stopping pumping during a long recovery period may constitute a problem to the well users. Therefore, a different approach is proposed for a) areas with relatively short recovery periods and b) areas with very long recovery periods.

- If the recovery period is relatively short, ranging from some minutes to some hours, agreement may be reached with the owner/user of the well to stop pumping for a period of time prior to the measurements. As an example, the break may start the day before the date of measurement. If such a solution is too hard for pumping well users stopping the well for a short period and measuring the recovery may be an option. In such case a measurement should be taken just before the break and, for instance, each five minutes during the break until the recovery is more or less complete (a criterion may be that difference between two subsequent measures is less than 1% of the first measured recovery step). The time period of measurements elapsed between the time that pumping is stopped and the moment that an acceptable recovery criterion is reached can be used as indication for the minimum duration of the break for future measurements on that site. Available data concerning the well discharge in the period before measurement should also be collected.
- For very long recovery periods (e.g. more than 24 hours), often corresponding with semi-confined aquifer systems of considerable thickness, the first method is not likely to work well. In such situations it may be decided to measure the piezometric level with the pumps on and to register the average pumping rate prior to the time of measurement. If the measured level is very unstable it maybe necessary to take several measurements and calculate the average. The number of pumping hours per day has to be taken into account if pumping is not a fully continuing process, e.g. when pumping stops for some hours during night time.

The best method for recording piezometric levels in production wells should be defined on the basis of hydrogeological and hydrological conditions in the area. It is important for interpretation of the data that the local situation is properly described. Finally there has to be a clear agreement between the well user(s) and the monitoring staff about the frequency and time of measurements and the length of the period that pumping will be stopped.

Piezometric level or groundwater head or pressure should be expressed as elevation above mean sea level or other uniform datum or ground level (UNESCO, 1998). This aspect needs particular attention in the case of transboundary aquifers as the used mean sea level could be different.

### C2.3 Characteristics and applicability of different measurement tools

There are extensive reviews of tools to monitor the groundwater quantity parameters (Nielsen, 1991; WMO, 1994; UNESCO, 1998, 2004; Margane, 2004). This annex (Annex C) gives an overview of most used monitoring tools, including recent developments, and of their applicability and limitations. Both manual-operated and automated-recording instruments are available to measure piezometric levels in boreholes (Table C1).

Any piezometric equipment should be constructed of materials that are chemically inert. Water level measurement equipment should be decontaminated prior to use to ensure water sample integrity and to prevent cross-contamination of groundwater.

The accuracy of piezometric level measurement is a function of the selected methodology and of the operational conditions. For many purposes an accuracy of 0.01 m can be considered sufficient.

#### *Wetted tape.*

A manual method, often called wetted tape, the most common in the past but no more often used, is to suspend a weighted plastic-coated tape or flexible steel cable from the well head to a point below the water level (UNESCO, 1998). The water level is determined by lowering into the well a weighted steel tape with the bottom coated for about a meter with carpenters chalk or pastes that change colour. The water level is calculated by subtracting the submerged tape length, as indicated by the lack of chalk, from the reference point at the top of the well. Water on the side of the casing or cascading water may wet the tape above the actual water level and result in measurement error. The wetted tape method is not recommended if quality monitoring is also realized because the chalk on the tape can contaminate the well water. Depths from 50 to 100 m can easily be measured.

#### *Dipper and Popper.*

The dipper is a cylindrical probe with a hollow space at the end, which is connected to a cable. When the dipper reaches the water table an audible signal is produced. The popper is quite similar: a metal cylinder with a concave bottom is attached to the bottom of tape or cable; a distinct "pop" can be heard when the cylinder is dropped onto the water surface. Usually the depth is determined after raising and lowering the probe a number of times over a distance of a few centimetres. The depth of the water equals the length of the tape or cable, usually measured at a reference point at the well head.

#### *Two-electrode device*

The two-electrode equipment consists of a portable reel with plastic-coated tape or cable connected to a probe at the cable bottom. The probe has two small adjacent electrodes. The circuit between the two exposed electrodes is closed when the probe reaches the water level. If the electrode materials are dissimilar a potential can be measured at the surface with a volt meter; if they are similar and a battery is added to the circuit a visible and/or audible signal is produced by a lamp or buzzer built into the reel. The depth of the water level is read from the cable. With this equipment water level up to 750 m deep can be measured. The maximum depth depends on the length of the electrical cable, the design of the electrical circuit and the acceptable weight and material of the equipment. The accuracy is comparable to the inertial device, although at great depth (in the order of 500 m) errors of 0.15 m are reported. However, if only variations in water level have to be measured at this large depth and always the same type of two-electrode equipment is used, an accuracy of millimetres is achieved. The very small diameter of the probe permits its use in very small piezometers. Measuring tapes and marked cables that are used to measure water levels should be periodically checked for stretch.

#### *Inertial device*

The inertial device is designed so that a weight attached to a cable moves downwards at a constant velocity. When the weight reaches the water level, a breaking mechanism stops the movement. A counter displays the depth of the water level. Depths greater than 100 m can be measured. Accuracy is high if the cable has negligible stretch.



### *Pressure transducer.*

The pressure transducer converts the water pressure in an electrical signal using a strain gauge or more expensive technologies. The relationship between the water pressure and the electrical signal is quite linear but should be determined in the laboratory, considering also the real cable and connections effects. The pressure transducer is lowered into the borehole below the deepest possible water level and stays there.

The cheaper technology guarantees a sufficient accuracy over only a limited range. Temperature affects both the electronic and the mechanical part of the transducer. Transducers measure water pressure relative to a reference value.

The reference value equals the atmospheric pressure if the transducers are vented to the atmosphere, usually through a suspension cable in which a thin plastic tube is present. This type of recording may be affected by obstructions or temperature changes due to sunlight and, therefore, requires periodical checking by manual measurement .

“Absolute pressure measurement” is obtained if the transducer measures gauge pressure in an evacuated chamber. This way of recording does not require frequent manual checking. However, subsequent water level calculations require a correction for barometric pressure, which involves an additional barometer in the close vicinity of the monitoring well(s).

Disadvantages over mechanical recorders are: lower life-expectancy, sensitivity to impact from lightning, intrusion of humidity, external temperature changes and instrumental drift. Drift must be controlled by regular manual measurements; other problems could be solved by a good design and installation. This device may be a good choice for remote locations exposed to vandalism and for wells which are not steady of artesian type. The pressure can be easily converted into a water height if the water density is known and is quite homogeneous and steady, conditions which are not given in the case of seawater intrusion or wide temperature ranges.

### *Mechanical float recorder*

The mechanical float recorder is widely applied. This device is based on a float that is linked to a counterweight by a cable that runs over a pulley. The device is above the well, and the float and the counterweight are in the observation well if the diameter permits. The accuracy, in general very high, increases as larger the float diameter is. The cable should be long enough to account for the groundwater fluctuation between the dates that the site is visited. The turn of the pulley is converted into a vertical movement of a pen on a drum chart, the rotation of which measures the time, or, by a shaft encoder, into a digital format that can be stored on a data logger. In the latter case the water level is not recorded continuously as in the former, but is stored only at set intervals. Careful maintenance is extremely important: every time the recorder is visited the recorded level should be checked against manual observations. Felt-tip pens or ink may dry up quickly under arid conditions. These must therefore regularly be serviced. Charts of chart recorders must be replaced commonly once a month, causing high personnel costs. Especially in remote areas it may be favourable to use data loggers instead. The float type method is considered to be a good compromise compared to other automatic recording methods also if the pressure transducer and ultrasonic sensors are being used increasingly.

### *Ultrasonic sensor*

An ultrasonic sensor transmits ultrasonic pulses which are reflected at the water surface and received again by the sensor. The time between transmission and receipt is linearly related to depth of water below sensor. Ultrasonic sensors can be placed either above or below the water surface but the latter solution should be avoided as it creates more maintenance problems. Ultrasonic sensors are sensitive to temperature and humidity. The ultrasonic sensor is generally connected to a data logger.

### *Air-line or bubble-in device*

The air-line submergence method is based on the bubble-in principle. A thin tube, with internal diameter of about 2 mm, made of plastic, copper, or steel, is installed along the well; the tube bottom should be located below the lowest water level. The tube and all connections must be air tight, without obstruction to the air flow. When air is pumped from the ground surface into the tube the air pressure will continue to increase until it expels all water from the line. Air pressure is then determined and used to calculate the height of groundwater above tube bottom. An air pump or compressor is useful

also if a hand air pump can be easily used for shallow boreholes. Modern equipment consists of a micro-piston pump built-in to the data logger system. The equipment is like a cylinder about 0.60 m in length and 0.05 in diameter. Due to the phase of emptying/filling of tube and the pump functioning, the frequency of measurement must be greater than 5 minutes.

#### Acoustic resonance sensor

The acoustic resonance in the air column of the borehole can be reached when the length of air column is equal to an uneven multiple of  $\lambda/4$  (with  $\lambda$  equal to the wave length) of the corresponding overtone (Margane, 2004). A sound signal is generated using a stable low-frequency generator emitting waves between 0.1 and 100 Hz. It can be used in not straight boreholes, small diameter and large depth. The measurement is temperature and humidity dependant and requires high energy consumption.

Table C1 - Instruments commonly used to measure piezometric levels

Type	AB	CS	Method	Readout device	Advantages, Accuracy	Disadvantages	Costs, skills
Manual	Yes*	No	Wetted-tape or flexible steel	Tape markings or steel ruler	Accurate if depth is not too large (max accuracy 0.003 m)	Several measurements needed to find approximate depth	Very low price and easy to produce and to use
	Yes*	NS	Dipper or Popper	Tape markings or steel ruler	Accuracy within 0.01 m, fast	Not-applicable in noisy environments	Very low price and easy to produce and to use
	Yes*	NS	Two-electrode devices	Tape markings	Fast and simple, small diameter and high depth, accuracy decreases with depth	Calibration, regular maintenance, batteries, repairs of cut cables source of errors	Low to moderately price, easy to operate
	Yes*	Yes	Inertial devices	Tape markings	Accuracy within 0.01 m, fast and simple	Counter calibration	Moderately price, easy to operate
	Yes	No	Manometer or Pressure gauge	Display or data logger	Fast and simple way for artesian well, accuracy from 0.03 to 0.15 m	No more useful when the well become not artesian, Calibration is required	Low to moderately price, easy to operate, checking
Automatic	Yes	Yes	Pressure transducer	Data logger	Max. accuracy from 0.002 to 0.010 m, simple	Temperature effect, connection with the open air, calibration	Medium to high price, regular checking
	No	Yes	Float recorder system	Drum chart or data logger	Accuracy from 0.001 to 0.005 m, widely applied	Float lag, mechanical failure, large well diameter	High price, regular maintenance and checking
	No	Yes	Ultrasonic sensors	Data logger	Accuracy from 0.005 to 0.020 m, simple, no contact with water	Temperature and humidity effects; under-water types should be avoided, straight borehole necessary	High price, regular checking
Both	No	Yes	Air-Line or bubble-in	Display or data logger	Accuracy from 0.01 to 0.08 cm	Installation not so simple, frequency measurement limitations	Medium to high price, regular checking
	No	No	Acoustic resonance sensor	Display or data logger	Small diameter, and large depth, not straight wells	The measurement is temperature and humidity effects; high energy consumption	Very high price

AB: Artesian Borehole,  
 (\*) Only with casing extension on ground surface (less than 2 m),  
 CS: Useful also for Channels and Springs,  
 NS: Not suggested.

References: Nielsen, 1991; OHIEPA, 1995; WMO, 1994; UNESCO, 1998, 2004; Margane, 2004.



## C2.4 Data collection, storage and transfer

The data collections can be organised on the basis of forms, drum charts or data loggers. The forms could be utilised by operators or by well owners, after a short learning period, to realize manual measurements.

Data loggers permit nowadays recording digital data. They are sealed solid-state units requiring infrequent battery changes (every year or less often, as a function of measuring and storing frequency). Information can be logged at different time intervals or according to a variable scheme. A better alternative is event-based logging where a reading is sampled at e.g. 15 s intervals and only stored in memory if it differs from the previous stored value by more than a set amount (ISO, 2003). Data can be downloaded by hand-held units, e.g. laptop computers, rugged hand-held computers or organizers. They can also be accessed by way of telemetric equipment.

Modern data loggers can be implemented in a storage-and-control subsystem (WMO, 1994). It can perform complex analysis of data in real time and use such analyses to compute derived information, compact data, or select some action. The subsystem decides on the basis of the value received from the measurement technology: for example, the subsystem can collect additional data or send signals to the telemetry subsystem, transmitting a warning or alert message.

The telemetry subsystem can be described considering three elements, which are the remote site, a borehole or a group of near monitored locations, the communications medium, such as phone or radio communication links, and the central receiving station.

The most common system of communication is one-way but a two-way communication system is also possible. In the first case the remote site starts transmission of data after a specified elapse of time or because data have exceeded some threshold value. In the latter case the remote station will transmit its data in reply to a command from the central station.

Power supply and vandalism are the main concerns for the remote site. If electrical power is unavailable, solar panels and rechargeable battery packs are a must. This has not only implications on the cost but may also increase the risk of vandalism. If data are transmitted only once a day, standard batteries may be sufficient; in any case, the remote apparatus are nowadays able to transfer data concerning the battery status reducing battery unloading risks.

Current telemetry subsystems rely on microwave, radio, or phone lines communications (WMO, 1994). In microwave communication, the transmission is line of sight, while radio transmission may be line of sight or relayed via an intermediate medium. This medium may be a terrestrial relay link or earth orbiting satellites.

The operational flow of data should be clearly organized, planning series of systematic and periodical controls.

A suggested procedure could be (UN/ECE, 1999):

1. Manual data entry from forms sent by observers:
  - A data entry typist controls and checks the entered data of another typist. After these checks, the data is given a first quality flag.
  - The entered data are stored in a shadow database.
2. Digital data entry from magnetic data carriers or received by the telemetric system:
  - Standard checks on trivial errors like typing errors, missing values, empty records, values out of range, incorrect code in strings or numbers, are applied on the data before shadow databases are generated.
3. Data entry from drum charts:
  - An expert technician transforms continuous drum chart data into a table of data for defined interval or digitizes the chart obtaining the same table using software.
  - Another technician checks the output.
  - The output obtained by software is the input for shadow databases; otherwise the output is sent to the step 1.
4. Periodical transfer and quality assurance operations:
  - All created shadow databases are added to the main database at the end of the defined monitoring interval (week, month, season or etc.) after passing the standard quality checks and

- any logical controls based on well location, depth of screens and well, measured piezometric depth, etc..
- The piezometric time series are checked by using typical approaches of time series analysis to detect unrealistic extreme values and the statistical homogeneity of data.
- Time series and new data are checked by plotting diagrams and maps, in this case using geostatistical tools.
- Data which are rejected are checked again.
- Every entered record receives a quality label providing information on how the data was entered.

## C2.5 Frequently observed problems

Practice of groundwater monitoring shows that problems of different nature related to practical or hydrogeological conditions or the type of equipment used, may negatively influence the results. In order to avoid that data are irreversibly lost or are unusable for the intended monitoring objective, it is recommended to look into problems and consider options of overcoming them. Some of these aspects have implications for the well design and should therefore be considered when designing the monitoring network. A concise description of some frequently found problems is given below (Margane, 2004).

### *Vandalism*

Vandalism is a big problem, especially in remote areas. The best option certainly would be using an underground installation which is therefore less visible. This is, however, not always possible, be it due to the too shallow water level, that surface water may leak inside after rainfall or flooding or that telemetric data transfer is intended to be used. Surface installations should be concealed in a stable enough housing that is sufficiently protected against forced entry. In built-up areas it may be useful and necessary to employ a guard. A better alternative is often to realize the monitoring installation inside public or private areas continuously utilized. In such case the payment of a compensation fee may be necessary, but in both cases a clear and official agreement is suggested to preserve access rights.

It is always recommended to make it public knowledge, for example with a simple and clear notice, that the monitoring site is a public investment which is in the common interest and that there is nothing much inside of value to take away.

### *Deviance of verticality and unevenness of the casing wall*

Boreholes must be drilled straight and the casing wall should be smooth, especially in the case of piezometers. Deviance from verticality or unevenness of the casing wall may cause problems to equipment, such as cables, probes and floats that may become stuck or may not work properly, such as for instance ultrasonic sensors which need to be on line of sight from the well head to water level. Therefore verticality must be ensured during drilling and only casing material that is smooth inside should be selected.

### *Water level recording in rock formations*

In rock formations in which the borehole is expected to be stable, such as limestones or sandstones, a casing is often not required for a pumping well and design as an open borehole may be considered. However, in a monitoring borehole installation of plain/screened casing may be necessary, depending on the depth of the water level, the depth of the aquifer and the type of monitoring equipment used, Especially floats may get stuck during the lowering of the water level, which will only be recognized when the charts are exchanged or the data are downloaded. It is therefore recommended to extend the plain/screened part of the casing at least to the depth of the lowest possible water level.

### *Continuously declining piezometric levels*

If piezometric levels are continuously declining due to overexploitation, it may be necessary to lower transducers down the well after some time. For such cases it is recommended to purchase equipment

which may be adapted to the expected changing conditions. Therefore the measuring range should be wide enough, the cable should be long enough and the facility for accommodating the additional cable length should be large enough. Moreover, and more importantly, boreholes must be deep enough so that measurements can be conducted over the entire lifetime of the monitoring program. If the lowering of the water level happens in heterogeneous aquifers, the changing saturated section of the well and of the aquifer may lead to quite complicated interpretation problems and also to a change of the hydrochemical (and isotopic) composition of the groundwater. In this case multi-piezometer should be utilized.

#### *Insufficient sealing*

If specific horizons in an aquifer or an aquifer overlain by another aquifer are to be monitored it must be ensured that the casing in those sections which are not to be monitored is absolutely tight. Normally this is done by telescoping down during drilling and casing off those 'unwanted' horizons with plain casing and annular sealants and/or cement. However, this is not always possible and annular sealants may not always be impermeable or not be at the position where they are supposed to be (the correct position may be checked using borehole geophysics, e.g. using clay triggered with magnetite and running magnetic logs). Also the casing of a borehole may start to leak not immediately after the installation but at some later time, e.g. due to rehabilitation works or if affected by land subsidence. It is therefore recommended to control the position of annular sealants and/or cement during installation and to test the tightness of connections at regular intervals.

#### *Problems related to land subsidence*

In the case of piezometric water level monitoring in land subsidence areas one possible monitoring objective may be water level monitoring in an area which is affected by land subsidence (KÜHN et al, 2003). In order to avoid that water levels or the hydrochemical composition measured by a monitoring well in such an area become non-representative or that such water from other than the specified aquifer starts to leak into the well, the following is recommended: the top and bottom of the screened section should be chosen based on assumed subsidence rates during the intended overall monitoring period; during the construction of the well head it must be ensured that the casing and well head can freely move and adapt to differential compaction and land subsidence.

### ***C3 Measuring discharge from wells and springs***

The discharge by wells, drainage galleries, base flow and springs can be determined with simple methods, hereinafter shortly described.

Springs and base flows provide an important source of groundwater supply in many areas, as arid regions. Artificial discharge of groundwater through horizontal galleries constitutes another important source of water supply for irrigation and human consumption in many areas of the Middle East, North Africa and parts of Asia (UNESCO, 1998). These sources, which are particularly sensitive to development using boreholes with motorized pumps, can be measured in the same way as springs. If the discharge and the water level of a spring are both measured, the discharge should be measured downstream, always in a point where the corresponding measurement of the water level is not influenced. Independent measurements are automatically obtained if the discharge is measured downstream of a hydraulic discontinuity, such as a small natural cascade.

Base flow measurements are usually included with the surface water monitoring network; a considerable amount of literature is available on the design of hydrometric networks (e.g. WMO, 1972).

Major springs and horizontal galleries should be identified and the discharge measured generally about once per month at or close to the point of discharge. The discharge from diffuse springs, such as many, near and small springs, is usually measured as stream flow immediately downstream the spring area. A detailed description of any kind of stream flow measurements is available from WMO (1972).

#### *Volumetric method*

The volumetric method is the simplest and probably cheapest method for measuring discharge. It consists of measuring the time it takes to fill a tank. The capacity of the tank (e.g. an oil drum) should be determined with the maximum possible accuracy. This method can only be used if the discharge rate is low with respect to the tank volume (the filling time should be not less than tens of seconds). It is only applicable if no continuous measurements are required since the tank(s) will have to be taken away and emptied before using it again.

#### *Discharge measurements using a weir*

A simple method of measuring well or low spring discharges is to use a weir tank with the water discharging over a V-notch or a rectangular notch. The accuracy of discharge measurements depends primarily on the accuracy of the water height and notch measurements, and on the applicability of the discharge formula coefficient used. Operating with care, the uncertainty attributable to the discharge coefficient will not be greater than 1% (ISO, 1980, 2003). It is essential to smooth out turbulence due to water entry, which can be achieved by applying a short rectangular approach channel or baffle plates.

The weir tank may be a portable one for periodical measurements and be dimensioned for a maximum flow of for example 20 l/s. For greater discharges two equal tanks or a more permanent structure may be used. Fixed equipment should be dimensioned for a reasonable discharge range. With this method the water level above the notch is measured most accurately inside a stilling well with a hook gauge or, for permanent installations, with a float-operated recorder or a pressure transducer. In any case the recorder should be capable of measuring water levels with a resolution of 1 mm.

#### *Orifice bucket method*

The orifice bucket consists of a small cylindrical tank with circular openings in the bottom (Kruseman & De Ridder, 1990). The discharge flows into the tank and outside through the openings. The tank fills with water to a level where the pressure head causes the outflow through the openings to equal the inflow. If the tank overflows, one or more orifices are opened. If the water in the tank does not rise sufficiently, one or more orifices are closed. A piezometer tube is connected to the outer wall of the tank near the bottom, and a vertical scale is fastened behind the tube to allow accurate readings of the water level in the tank. A calibration curve is required, showing the rate of discharge through one or more orifices.

#### *Volumetric meter method*

If it is simple tapping the flow in a pressurized tube, it is quite simple and cheap to use a commercial volumetric water meter together with a chronometer. The total flowed volume is read periodically from the meter, the volume flowed between two consecutive readings is calculated and divided by the elapsed time. Electronic totalling flow meters can be used together a data logger.

#### *Rotametre tube method*

The variable-area meter, called rotameter, consist essentially of a tapered tube and a float. It is easily installed along tubes by flanged-end but it must be installed vertically. The float rests freely at the bottom of the tube if the flow is null. As liquid enters the bottom of the tube, the float begins to rise. The position of the float varies directly with the flow rate. Its exact position is at the point where the differential pressure between the upper and lower surfaces balances the weight of the float; so it utilizes a constant differential pressure. Considering advantages, the flow rate can be read directly and continuously on a scale mounted next to the tube, without secondary flow-reading devices. However, automatic sensing devices can be used to sense the float. Rotametre tubes are manufactured from glass, metal, or plastic for different ranges of flow.

#### *Orifice plate method*

The orifice plate is a popular device to measure the rate of flow in a circular tube under pressure. It is practically a perfect round hole in the centre of a circular steel plate which is fastened to the outer end of the discharge pipe. The orifice plate can be placed or not immediately before the free discharge into a tank or basin. The well or spring discharge is calculated from the height measurement taken from a thin piezometer connected to the pipe or a manometer and from the specific characteristics of the geometry of the pipe and orifice. Numerous combinations of pipe and orifice sizes can be used (ISO, 2003). Carrier-rings with single bore and fixed orifice plate are commercially available for any condition of installation. They can use, sharp edged, rounded or quarter circle nozzle cylindrical orifice, a segmental or double coned orifice according to appropriate conditions of use. The orifice plate may either be welded or screwed into the carrier-ring or may be manufactured as single piece. An orifice may be also machined from a threaded pipe cap or from 4 mm to 7 mm steel plate stock and attached to the pipe by a threaded coupling. The orifice should be carefully machined into the plate or cap as a true circle that is sharp, clean and free from any rust, pits or imperfections. The recommended ratio of the orifice diameter to the inside diameter of the discharge pipe is 0.4 to 0.85 (ISO, 2003).

#### *Venturi tube method*

The Venturi tube is a classical application to flow measurement in the case of also slightly pressurized conduit flow. It consists, in the flow direction of an inlet cylinder, an inlet cone with decreasing diameter, an outlet with increasing diameter which is followed by a cylindrical neck with tube diameter. The flow measurement is obtained by a differential pressure measurement between the upward Venturi section and the narrowest one. Classical Venturi tubes are being carried out in several types of construction; Venturi tubes are realized with treated inlet cone, inlet cylinder and neck or Venturi tubes with rough, with welded inlet cone. Venturi tubes cause very low pressure losses and they need only very short upstream paths.

#### *Indirect calculation of water discharged by wells*

If an electric pump is used and the whole characteristics of the system constituted by source of power, pump, hydraulic connections are well known, the pumped volumes and the discharge can be evaluated on the basis of electrical energy consumption (López et al., 1998); the electrical measure is practically free of charge in the case of electrical supply by a company exclusively utilized for pumping. If the system can not be well characterized, a calibration should be realized.

Table C1: Selection of simple methods commonly used to measure groundwater discharge

<i>Method</i>	<i>Well</i>	<i>Spring</i>	<i>Open channel flow</i>	<i>Pressurized conduit flow</i>	<i>Manual or Automatic</i>	<i>Accuracy</i>	<i>Advantages</i>	<i>Dis-advantages</i>	<i>Costs</i>
Volumetric tank	Yes	Yes	Yes	NS	M	Function of the tank volume and of time measurement	Transportable equipment, very easy to produce	Applicable to low discharge, discontinuous	Very low
Notch discharging section	Yes	Yes	Yes	NS	Both	Function of the water height and notch measurements, upward low velocity necessary	Transportable and modular equipment, easy to produce	Expert operators and hydraulic calculations need	Low
Orifice bucket	Yes	Yes	Yes	NS	M	Function of the water height measurement and of calibration	Transportable and modular equipment, easy to produce	Expert operators, hydraulic calculations and calibration need	Low
Volumetric water meter	Yes	Yes	No	Yes	Both	Function of the mechanical construction and of calibration	Simple management of measures, low energy losses	Problem in the case of appreciable turbidity or solid particles flow	Low to medium
Rotameter	Yes	Yes	No	Yes	Both	Function of the mechanical construction and of calibration	Simple management of measures, low energy losses, continuous	Vertical installation, range not so wide	Low to medium
Orifice plate	Yes	Yes	No	Yes	Both	Function of the water height measurement and of mechanical construction or of calibration	Simple management of measures, low energy losses, equipment can be produced by turner or expert worker	Problem in the case of appreciable turbidity or solid particles flow	Low to medium
Venturi tube	Yes	Yes	No	Yes	Both	Function of the pressure measurement and of mechanical construction or of calibration	Simple management of measures, low energy losses, equipment can be produced by turner or expert worker	Calibration useful if self-produced	Low to medium

NS: not suggested.

References: UNESCO, 1998; WMO, 1972; ISO, 1980, 2003; Kruseman & De Ridder, 1990; López et al., 1998.



## **C4** *References and recommended literature*

### **References**

- Bartram J. & Balance R. (1996) - Water quality monitoring. UNEP, WHO, London.
- ISO (1980) - Water flow measurement in open channels using weirs and Venturi flumes - Part 1: Thin-plate weirs.. Int. standard, 1438-1, Geneva.
- ISO (2003) - Hydrometric determinations - Pumping tests for water wells - Considerations and guidelines for design, performance and use. Int. standard, 14686, Geneva.
- Kruseman G. P. & De Ridder N.A. (1990) - Analysis and Evaluation of Pumping Test Data. ILRI, Wageningen, 378 pp.
- Kühn F., Margane A., Tatong T., & Wever T. (2004): InSAR-based land subsidence map for Bangkok/Thailand. Zeitschrift für Angewandte Geologie (ZAG), 50, 104, Stuttgart, Germany.
- López Geta J.A., Rubio Campos J.C., González Ramón A., Delgado Pastor J. & Sánchez Pérez J. (1998) - Guía para la evaluación de extracciones de aguas subterráneas mediante contadores eléctricos. Rendimiento y coste del agua. IGME), Madrid, Spain.
- Margane A. (2004) – Guideline for groundwater monitoring. BGR and ACSAD Technical Cooperation Project “Management, protection and sustainable use of groundwater and soil resources in the Arab Region”, 7, Damascus.
- Nielsen (1991) - Practical handbook of ground-water monitoring. Lewis Publishers, Chelsea, pp 717.
- OHIEPA (1995) -Technical guidance manual for hydrogeologic investigations and ground water monitoring. Ohio Environmental Protection Agency, Columbus, Ohio, USA.
- USEPA (1991) - Handbook of suggested practices for the design and installation of ground-water monitoring wells. US-EPA, 160014-891034, Ed. by Aller L. T., Bennett W., Hackett G., Petty R. J., Lehr J. H., Sedoris H., Nielsen D.M. & Denne J. E. Las Vegas, Nevada.
- USEPA (1992) - RCRA Ground-Water Monitoring Draft Technical Guidance. U.S. EPA, Office of Solid Waste, Washington, D.C..
- UNESCO (2004). Groundwater studies. UNESCO IHP VI, Series on groundwater, 3, Ed. by Kovalevsky V.S., Kruseman G.P. & Rushton K.R., Paris.
- UNESCO (1998) - Monitoring for Groundwater Management in (Semi-) Arid Regions. UNESCO, Studies and Reports in Hydrology, 57, Ed. by Henny Dr. Ir & van Lanen A. J., Paris.
- UN/ECE (1999) – State of the art on monitoring and assessment of groundwater. Task force on monitoring & assessment, Lelystad.
- WMO (1972) – Casebook on hydrological network design. World Meteorological Organisation, 324, Geneva.
- WMO (1994) - Guide to hydrological practices. World Meteorological Organisation, 168. Geneva.

### **Recommended literature**

- Taylor C. J. & Alley W. M. (2001) - Ground-Water-Level Monitoring and the Importance of Long-Term Water-Level Data. USGS, Circular 1217.
- UN/ECE (2000) – Guidelines on Monitoring and Assessment of Transboundary Groundwaters. Task force on monitoring & assessment, Lelystad.
- USEPA (1989) - Ground-Water Monitoring in Karst Terrains: Recommended Protocols and Implicit Assumptions. EPA, 600/X-89/050, Ed. by Quinlan J. F., 79 pp.



## Annex D: Groundwater quality sampling

Annex D duplicates a part of:  
*Volume 6 - Manual on "Groundwater Quality Sampling"*  
produced and published by the "Hydrology Project", India.

When carrying out a groundwater quality sampling campaign, the main objective should be to obtain a representative water sample of the groundwater system under investigation and to store and transport it to the laboratory for analysis with minimal disturbance. The procedures used to collect, store and analyze groundwater quality samples, and to evaluate analytical results should ensure that the data are of the type and quality necessary to meet the objectives of the monitoring programme.

### *D.1 Field measurements*

Some groundwater quality parameters are likely to change significantly after sample collection as a result of temperature change, degassing, mineral precipitation, and other chemical, physical, and biological reactions, and should be measured immediately in the field rather than in the laboratory. In the context of the present programme, there are five physico-chemical parameters which are usually measured in the field (also called, field parameters). These parameters are temperature (T), pH, specific electrical conductance (SEC), oxidation reduction potential (ORP) and dissolved oxygen (DO).

A description of the field techniques which can be adopted to measure these parameters in the field can be found in the following sections. Measurements of field parameters must represent aquifer conditions and should be measured in the field, as close to the groundwater source as possible, either down hole or within a multiport flow-through cell connected in-line to the sampling points.



*Figure D.1: Measurement of groundwater field parameters using a multiport flow-through cell*

### ***Measurement of Temperature (T)***

Groundwater temperature is a measure of the warmth or coldness of the water with reference to a standard value. It is usually measured in degrees Celsius using either a liquid-in-glass thermometer or a thermistor thermometer, an electrical device often incorporated in most of the other instruments used for measuring other water quality measurements in the field (e.g., pH or EC).

A thermometer may be calibrated in the laboratory comparing the temperature readings to those of a thermometer of certified accuracy. If not available, it is always possible to cross-check the readings in the field by comparing readings with another field thermometer.

Groundwater temperature data provide valuable information to interpret the chemistry of the water sample (approximate sampling depth, degree of mixing) and the thermal variations induced by natural or human impacted processes.

### ***Measurement of pH***

Groundwater pH is a measure of the activity of the hydrogen ion in logarithmic units ( $\text{pH} = -\log [\text{H}^+]$ ). Measurement of pH is carried out to determine the acid ( $\text{H}^+$ ) base ( $\text{OH}^-$ ) balance of the water on a common scale of 0 (strongly acidic) to 14 (strongly alkaline). In acid mine drainage it is common to have pH of less than zero.

Measurement of pH can be either electrometric using a hydrogen ion electrode, or colorimetric, using indicator paper (which changes colour depending upon the pH of the water). As portable pH meters are now relatively inexpensive this is now the preferred method of measuring pH as indicator papers just provide rough estimates. pH meters should be calibrated everyday before going to the field using certified buffer solutions.

### ***Measurement of Specific Electrical Conductance (SEC)***

Groundwater specific electrical conductance (also called, electrical conductivity) is a measure of the ability of water to conduct electrical current, and is directly related to the type and concentration of dissolved ions in solution. However, there is no linear correlation between the groundwater conductivity and the concentration of dissolved solids in the water.

Conductivity is usually reported in micro siemens per centimetre at 25 degrees Celsius ( $\mu\text{S}$  at  $25^\circ\text{C}$ ) Measurements of SEC may be carried out using one of the many types of conductivity instruments with a purpose-built in conductivity meter and temperature sensor (for automatic or manual compensation).

NOTE: Rather than use separate meters for temperature, pH and conductivity it is possible to purchase a single instrument which will measure all three parameters. However, such an instrument *may* be more expensive than single parameter meters.



*Figure D.2: Conductivity meter with thermistor thermometer incorporated*

### ***Measurement of Oxidation-reduction potential (ORP)***

Oxidation-reduction potential (ORP) is a measure of the equilibrium potential relative to the standard hydrogen electrode, developed at the interface between a noble metal electrode and an aqueous solution containing electro active redox species. However, in natural groundwater ORP measurements should be considered as just indicative and never as equilibrium values.

ORP can be measured in the field with a purpose-designed redox-sensing combination electrode or an electrode pair (a platinum and reference electrode) and meter in mV. It is very important to use the correct electrolyte filling solution specified by the electrode manufacturer.

Before measuring the ORP it is necessary to calibrate the meter. This should be carried out at least once per day, before the first measurement is taken. ZoBell's (0.1 molal KCl solution containing equimolar amounts of  $K_4Fe(CN)_6$  and  $K_3Fe(CN)_6$ ) is the standard solution for testing redox instruments, and it can be obtained commercially or it can be prepared.

Once calibrated, the ORP of the groundwater can be measured by immersing the electrode in a sample of water as soon as it is taken. Contact with air should be prevented as much as possible. It is important to remember that an ORP electrode often takes some minutes to stabilise, the reading must, therefore, be taken after this stabilisation has occurred.



*Figure D.3: pH and ORP meter with thermistor thermometer*

**Measurement of Dissolved Oxygen (DO)**

Dissolved oxygen is the molecular oxygen (oxygen gas) dissolved in groundwater and is very important to trace changes in groundwater composition produced by natural and human impacted activities. Two field methods for determining concentrations of dissolved oxygen in groundwater are the amperometric method and the spectrophotometric method (the Rhodazine-D™,1 technique). The amperometric method is the standard measure and consists of a temperature-compensating instrument or meter that works with a polarographic membrane-type sensor. Calibration and operation procedures for the available methods differ among instrument types and makes, and should be verified reading manufacturer's instructions.



*Figure D.4: DO meter with thermistor thermometer*

## D.2 Groundwater sampling

### General

- At least one day before sampling, make sure that all the arrangements are made (see Checklist, Table D.1).
- Make sure that you know how to reach sampling site(s). Take help of location map for the site which shows the sample collection point with respect to prominent landmarks in the area. In case there is any deviation in the collection point, record it on the sample identification form giving reason.
- Rinse the sample container at least three times with the sample before it is filled.
- Leave a small air space in the bottle to allow mixing of sample at the time of analysis.
- Label the sample container properly, preferably by attaching an appropriately inscribed tag or label. The sample code and the sampling date should be clearly marked on the sample container or the tag.
- Complete the sample identification form (Table D.3) for each sample.
- The sample identification form should be filled for each sampling occasion at a monitoring station. Note that if more than one bottle is filled at a site, this is to be registered on the same form.
- Sample identification forms should all be kept in a master file at the level II or II+ laboratory where the sample is analysed.

Table D.1: Checklist for water quality sampling field visit

• Itinerary for the trip (route, stations to be covered, start and return time)	• Personnel and sample transport arrangement
• Area map	• Sampling site location map
• Icebox filled with ice or icepacks	• Weighted bottle sampler
• BOD bottles	• Rope
• Special sample containers: bacteriological, heavy metals, etc.	• Sample containers
• Sample preservatives (e.g. acid solutions)	• Thermometer
• Tissue paper	• Other field measurement kit, as required
• Sample identification forms	• Labels for sample containers
• Field notebook	• Pen / pencil / marker
• Soap and towel	• Match box
• Spirit lamp	• Torch
• Drinking water	• Knife
• Waste container	• Gloves and eye protection

Note that depending on the local conditions, water body, analysis requirements, etc., not all items on the check list may be necessary. Other items, not listed, may be required.

### Sample collection

Groundwater samples should be taken from the discharge during pumping conditions and once stabilisation of the principal field parameters is attained.

- Samples for groundwater quality monitoring would be collected from one of the following three types of wells:
  - Open dug wells in use for domestic or irrigation water supply,
  - Tube wells fitted with a hand pump or a power-driven pump for domestic water supply or irrigation
  - Piezometres, purpose-built for recording of water level and water quality monitoring.

- Open dug wells, which are not in use or have been abandoned, shall not be considered as water quality monitoring station.
- Use a weighted sample bottle to collect sample from an open well about 30 cm below the surface of the water (See Figure 1). Do not use a plastic bucket, which is likely to skim the surface layer only.
- Samples from the production tube wells will be collected after running the well for about 5 minutes.
- Non-production piezometres should be purged using a submersible pump. The purged water volume should equal 4 to 5 times the standing water volume, before sample is collected.
- For bacteriological samples, when collected from tube wells/hand pump, the spout/outlet of the pump should be sterilised under flame by spirit lamp before collection of sample in container.

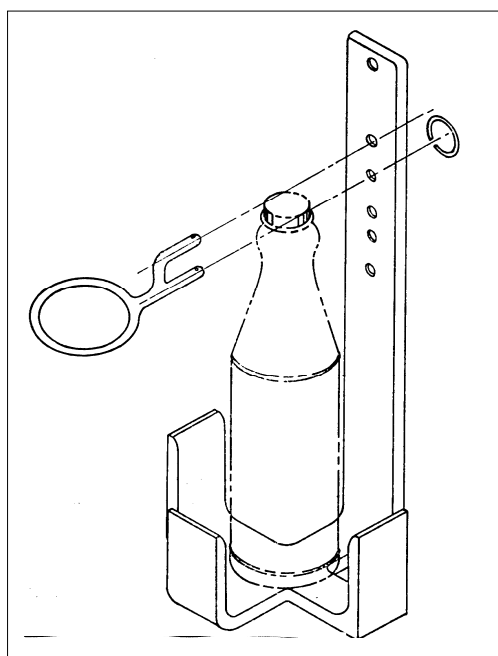

*Figure D.5: Weighted sample bottle holder for sampling*

### ***Selection of sample containers***

In order to cover the range of parameters which need to be sampled and analysed, a variety of sample containers are used. The different types are reviewed here again and briefly discussed:

- 1000 millilitre glass (or teflon) bottles with teflon lined caps - for pesticides and phenols
- 500 millilitre polyethylene bottles - for metals (except mercury)
- 100 millilitre glass bottles - for mercury and phosphorus
- 1000 millilitre polyethylene bottles for all other chemical parameters
- BOD bottles, with ground glass stoppers, of a volume consistent with the dissolved oxygen samplers (possibly 300 millilitre)
- Strong thick-walled glass bottles of at least 300 millilitre capacity for microbiological analysis. These should be fitted with screw caps capable of maintaining a good seal even after multiple sterilisations in an autoclave

Note that the type of container and the number of containers needed depend on the parameters selected for monitoring.

Table D.2 gives the required type of container, the suggested volume of sample and the recommended sample-pre-treatment for most common parameters.

*Table D.2: Water quality parameters - Sampling containers and pre-treatments required*

Parameter Group	Parameter	Sample Container	Sample Pre-treatment
General	Temperature	On-site analysis	On-site analysis
	Suspended Solids	1	None*
	Conductivity	On-site analysis	On-site analysis
	pH	On-site analysis	On-site analysis
	Dissolved Oxygen	2	7
	Dissolved Solids	1	None*
Nutrients	Ammoniacal Nitrogen	3	8
	Total Oxidised Nitrogen	3	8
	Total Phosphorus	4	None*
Organic Matter	Chemical Oxygen Demand	3	8
	Biochemical Oxygen Demand	2	4°C, Dark
Major Ions	Sodium	3	None*
	Potassium	3	None*
	Calcium	3	None*
	Magnesium	3	None*
	Carbonates and Bicarbonates	1	None*
	Chloride	1	None*
	Sulphate	1	None*
Other Inorganics	Silica	1	None*
	Fluoride	1	None*
	Boron	1	None*
Metals	Cadmium	3	9
	Mercury	4	9
	Zinc	3	9
Organics	Pesticide (Indicator)	5	4°C, Dark
	Synthetic Detergents	1	None*
	Organic Solvents	1	4°C, Dark
	Phenols	5	8
Microbiological	Total coliforms	6	4°C, Dark
Biological	Chlorophyll 'a'	1	4°C, Dark
<p>NOTES:</p> <p><i>Containers:</i></p> <ol style="list-style-type: none"> <li>1000 millilitre polyethylene bottle</li> <li>Special BOD bottle (normally 300 millilitre)</li> <li>500 millilitre polyethylene bottle</li> <li>100 millilitre glass bottle</li> <li>1000 millilitre glass (or Teflon) bottle with Teflon lined caps</li> <li>Strong thick-walled, screw-capped glass bottle (300 millilitre capacity). Only good quality will maintain a good seal after multiple sterilisations in an autoclave</li> </ol> <p><i>Preservation:</i></p> <ol style="list-style-type: none"> <li>Samples for dissolved oxygen analysis are fixed by adding 1 ml of manganous sulphate solution, 1 ml of alkaline iodide-azide solution and 1 ml of concentrated sulphuric acid to the sample and mixing. Care should be taken to ensure that no air is added to the sample during this process.</li> <li>Samples should be acidified with 2 ml of concentrated sulphuric acid</li> <li>Samples should be acidified with 2 ml of concentrated nitric acid.</li> </ol> <p>*None: Ideally, <i>all</i> samples should be kept cool and in the dark after collection. If this is not possible, then at least samples for BOD, coliforms, chlorophyll, pesticides and other organics that are likely to volatilize MUST be kept at 4°C, and dark. Remaining samples can have no preservation.</p>			

### ***Preparation and Sterilisation of Equipment***

This section summarises the equipment requirements for the purpose of field sampling preparation. In general, bottles which are to be used for collecting samples must be thoroughly washed and rinsed before use. Washing can be done by hand but, if there are many bottles to wash, it is often best undertaken by machine.

Bottles which are to be used for collecting microbiological samples must be thoroughly washed and sterilised before use. Sterilising can be carried out by placing the bottles in an autoclave at 121°C for fifteen minutes or, if the caps of the bottles do not contain plastic or rubber materials, in an oven at 170°C for at least two hours. Thus, any laboratory that needs to prepare bottles for microbiological samples requires either an autoclave capable of comfortably sterilising at least twenty bottles at one time or an equivalent size sterilising oven.

Bottles to be used for the collection of pesticides are to be rinsed with organic solvent (e.g. hexane) prior to use. This should be done in the laboratory.

### ***Sample Labelling***

Label the sample container properly, preferably by attaching an appropriately inscribed tag or label. Alternatively, the bottle can be labelled directly with a water-proof marker. Information on the sample container or the tag should include:

- sample code number (identifying location)
- date and time of sampling
- source and type of sample
- pre-treatment or preservation carried out on the sample
- any special notes for the analyst
- sampler's name

### ***Application of sample identification forms***

The sample identification form provides a record of all important information concerning the sample collected. Complete the sample identification form at each monitoring site, detailing the samples that are collected at that site. Note that if more than one bottle is filled at a site, for different types of analyses, this is to be registered on the same form.

Local conditions, such as garbage in a well or visible pollution around a well as at the sampling site should be recorded on the form, at the time of sampling. Such information may be useful in analysis of data.

The form for identifying the sample and recording the field measurements and site conditions is given in Table D.3. Duly filled-in sample identification forms should be given to the laboratory analyst together with the samples. The forms should all be kept in a master file at the level II or II<sup>+</sup> laboratory where the samples are analysed.



Table D.3: Sample identification form for groundwater samples

Sample code												
Observer				Agency				Project				
Date			Time			Well code						
Source of sample: <input type="radio"/> Open dug well <input type="radio"/> Hand pump <input type="radio"/> Tube well <input type="radio"/> Piezometer												
Parameter code	Container				Preservation				Treatment			
	Glass	PVC	PE	Teflon	None	Cool	Acid	Other	None	Decant	Filter	
(1) General												
(2) Bacteriological												
(3) BOD												
(4) COD, NH <sub>3</sub> , TON												
(5) H Metals												
(6) Tr Organics												
Field determinations												
Temp	°C	pH		EC								µmho/cm
Odour code	(1)	Odour free		(6)	Septic				Colour code			
	(2)	Rotten eggs		(7)	Aromatic							
	(3)	Burnt sugar		(8)	Chlorinous							
	(4)	Soapy		(9)	Alcoholic							
	(5)	Fishy		(10)	Unpleasant							

Table D.4: Form for well purging

IF WELL IS PURGED, COMPLETE BELOW:

Office Well Data			
Diameter	φ		cm
Depth	D		m
Static water level (avg)	SWL		m
Water column (D-SWL)	H		m
Initial volume well	V		L
Projected pump discharge	PQ		L/s
Projected time of purging (V/PQ)	PT		min
Field Flow Measurements			
Static water level on arrival	SWL		m
Actual pump setting			m
Purging duration			min
PUMP DISCHARGE BEFORE	Q		L/min
PUMP DISCHARGE AFTER	Q		L/min
Volume purged	V		L
Dynamic water level	DWL		m
Field Chemical measurement			
TIME AT START OF SAMPLING	T (°C)	EC(µmho/cm)	pH
+10 min			
+20 min			
+30 min			
+40 min			

### ***D.3 Sample Handling***

The preservation, transportation and storage of samples is another vital link in the sampling chain as failure to carry out these operations with sufficient care can change the characteristics of the sample and lead to incorrect analytical results. There follows below, therefore, some guidelines on how these procedures should be undertaken.

#### ***Sample Preservation***

As a general rule, all water quality samples should be stored at a temperature below 4°C and in the dark as soon after sampling as possible. However, this might not be practical for a large sampling campaign. If it is not possible to keep all samples cooled and dark, then at least samples for BOD, coliforms, pesticides and other organics that are likely to volatilize **MUST** be kept at 4°C, and dark (see Table D.2). In the field, this usually means placing them in an insulated cool box together with ice or cold packs. Once in the laboratory, samples should be transferred as soon as possible to a refrigerator. Cooling serves the purpose of reducing the reaction rate of all bio-chemical reactions taking place in the sample and thus slowing down undesired changes in the quality of the sample.

- If samples collected for chemical oxygen demand (COD) analysis cannot be determined the same day they are collected they should be preserved below pH = 2 by addition of concentrated sulphuric acid. This procedure should also be followed for samples for ammoniacal nitrogen and total oxidised nitrogen analysis.
- Samples which are to be analysed for the presence of metals should be acidified to below pH = 2 with concentrated nitric acid. Such samples can then be kept up to six months before they need to be analysed. Mercury determinations should be carried out within five weeks, however.
- After labelling and preservation, the samples should be placed in an insulated cool box for transportation (Figure 2). Samples should be transported to concerned laboratory (level II or II<sup>+</sup>) as soon as possible, preferably within 48 hours.
- Analysis of bacteriological samples should be started and analysed within 24 hours of collection.
- If samples are being brought to a Level I laboratory for the 'field determinations', they should be transported in less than 24 hours.
- Some samples need to be preserved or fixed in the field. For dissolved oxygen fixing, every field operative should bring three pipetted glass or plastic stoppered 500 millilitre bottles containing the DO fixing solutions. As these solutions can be corrosive the three bottles should be carried in an appropriately sized bottle carrier to ensure they do not tip over and spill their contents.
- For other parameters, (e.g. COD, NH<sub>3</sub>, NO<sub>2</sub><sup>-</sup>, NO<sub>3</sub><sup>-</sup>) addition of concentrated sulfuric acid should be done in the field after sampling. For heavy metals, addition of nitric acid needs to be done in the field after sampling. Therefore, the field operative should be equipped with two pipetted glass or plastic stoppered 100 millilitre bottles containing the two acids.

#### ***Sample Transportation***

Normally, a motor vehicle with a reasonable weight carrying capacity, such as a light van or car, should be used for water quality sampling. This is because a one (or more) day sampling campaign encompassing a number of sampling points can mean that many bottles of water are collected. This is particularly the case where a range of parameters are to be determined each of which requires a different type of sample bottle.

Transporting samples by public transport like bus or train is possible but the weight of the cool-box containing several filled sample bottles and ice will easily exceed a weight of 10 kg and may not be easy to handle.

For economic reasons and the necessity of analysing the collected samples as soon as possible (some preferably within a day) it is best to plan a sampling campaign such that it can be completed in one day. Ideally, this will entail visiting a number of sampling points in a logical order and ending the day's journey at the laboratory where the samples can be analysed or at least refrigerated until the following day. If samples cannot be analysed until the following day, such sampling campaign should not be carried out the day before a laboratory staff holiday.

Initially all sample containers are sent to the laboratory that is involved in organising the monitoring campaign. If needed samples, may be forwarded from there only for advanced analyses in a higher level laboratory.

### ***Sample storage***

Sample storage, by definition begins immediately after the sample is collected, therefore some discussion about storage is given here.

Ideally all samples need to be stored in the dark and below 4°C so that the determinand values do not change. In practice, this treatment may not be possible for all parameters. However, samples for BOD, coliforms, chlorophyll, pesticides and other organics that are likely to volatilise should always be kept cool and dark. For this reason it is good practice to store these water samples during transportation in a cool box. After arrival in the laboratory the samples should be transferred to a refrigerator until they can be analysed. Sample storage usually takes place at the same location where the samples eventually will be analysed.

## ***D.4 Equipment***

### ***Samplers***

The preferred type of sampler in the field for groundwater sampling is the submersible pump. The sampler should be cleaned and rinsed. Sampler should also be briefly checked for functioning, closing of caps, if applicable, and condition of the cable by which the submersible pump will be lowered inside the well.

To take a representative sample, the sampling procedure should meet the following requirements:

- allows removal of stagnant water from the well (called purging) by means of a submersible pump so that the sampled water represents the water in the aquifer;
- avoids degassing of the sample and volatilisation of components in it;
- prevents oxidation caused by contact with the atmosphere, and
- avoids contamination of the sample and the well.

Three conventional methods and one sophisticated technique are reviewed briefly with respect to their capability of providing representative samples as follows:

#### *Conventional Techniques* (not recommended under HP)

- *Bailers* or *depth samplers* are the grab samplers that operate by lowering the device to a known depth in the water column, closing the valve at the bottom and raising it to the ground surface. Major limitation is the high atmospheric contact during sampling. Furthermore, bailers are difficult to clean (dead-volumes) and the risk of cross-contamination from one well to another (cross-contamination) is high. In addition, contamination of the well water during sampling can be foreseen when a large bailer scrapes the casing of small diameter wells. Purging of the well before sampling by the use of bailers is very time-consuming.
- *Suction devices* lift the water sample by applying suction directly to the water or via a collection bottle. Suction can either be generated manually or by a pump (e.g. peristaltic or centrifugal type) but the sampling depth is limited to 8 or 10m. The major limitation is degassing and aeration that cannot be controlled. As with bailers, effective purging is very time-consuming using suction devices.
- *Gas-driven devices* apply gas (air) creating positive pressure directly on the water that drives it from the borehole - back flow being prevented by check valves. Usually compressed air is pumped down the borehole through a delivery tube. The air then forces water up through a second tube (acting as an airlift pump) and the air water mixture emerges at the head of the well. The intense contact between high-pressure air and the water causes oxidation and disturbance in the dissolved gas balance of the waste water, namely, degassing and volatilisation, which in turn can cause

precipitation of contaminants. This will mean that the sampled water is no longer representative of the groundwater from which it is taken.

Sophisticated Technique (recommended under HP):

- *Submersible pumps* are lowered into the borehole and water is driven out continuously at the surface. The following three principles are used to drive out the water: gears or rotor assembly (electric centrifugal pump), gas-operated plunger (piston pump) or a gas operated diaphragm (bladder pump). Submersible pumps of these three types are rated acceptable for sampling groundwater for all parameters, including volatile organic carbon, trace metals and dissolved gasses and is therefore recommended as the lifting device for the current water quality programme under HP.

If a submersible pump is used to obtain water samples from boreholes, it should ideally have the following characteristics:

- *Variable pumping rate:* A variable pumping rate is necessary to allow high speed for rapid purging and slower speeds for sampling (less than or equal to 0.1L/min).
- *Size:* The outer diameter of the pump should be considerably less than the smallest inner diameter of the boreholes or piezometers in the monitoring programme. A gap of at least 3cm is needed all around to guarantee that the pump does not scrape/damage the sides of the wells during lowering and lifting. The smaller the pump compared to the inner diameter of the well, the easier the lowering and lifting will be. If the well is equipped with a digital water level recorder (DWLR), it is recommended that the DWLR is removed before insertion of the submersible pump to avoid physical damage to the equipment, tubes or cables.
- *Material:* The material of the pump, tubing and fittings (all parts that make contact with the well water) should be inert and resistant to corrosion. The most common material used is stainless steel.
- *Power supply:* A portable power generator set together with an adjustable frequency converter (to regulate the pumping speed) is required.
- *Portability:* The weight and size of the complete set of generator and accessories should be such that it could be easily transported even through off-road terrain. A lighter set is easier to handle and will increase the ease and speed of transportation and positioning.
- *Noise:* The noise level of the sets should be acceptable and for this purpose an exhaust silencer with muffler is advised.
- *Cleaning:* The pump and the tubes must be easy to clean (no 'dead-volumes') in order to avoid cross-contamination of wells.
- *Maintenance and repair:* The pump must be easy to repair in the field and all tools and spare parts must be included with the portable set.
- *Accessories:* A water level indicator and a field kit mounted with probes for analysing/monitoring parameters, like temperature, pH, conductivity and ORP are worth considering.

For manual sampling of hand-dug wells (which cannot be purged) all that is required is a weighted sampling can with a rope attached to its handle (Figure D.5). The can is then carefully lowered down the well until it fills with water and is then brought out of the wall. Although virtually any style of sampling can is acceptable for this application, there are a number of features that are preferable as follows:

- *Small volume and diameter:* It is preferable that the sampling can has a relatively small volume and diameter. This makes it easier to haul the can up the well when it is full of water and helps to ensure that the can does not touch the sides of the well.
- *Plastic:* This makes the sampling can lighter, easier to clean and less likely to chemically react with the parameters to be determined in the water sample. For the same reasons the rope attached to the bucket should also be made of a synthetic fibre.
- *Lipped:* The provision of a lip to the sampling can makes pouring the water into a sample bottle much easier.

The simplest form of a water sampling device is a bottle attached to a string. To lower a plastic or glass bottle in a body of water it is necessary to use a bracket or holder of sufficient weight to overcome the buoyancy of the bottle and allow it to sink as rapidly as desired to the required depth. Such a holder designed to contain a one or two litre bottle is shown in Figure D.6.

### ***Transportation Boxes***

After labelling and preservation, the samples have to be packed for transport, preferably in an insulated cool box. After sampling, many water quality parameters undergo chemical or biochemical reactions in the sample bottle causing the concentration to change from that which was present in the watercourse. To prevent this alteration of parameter values, ideally all samples should be kept at a temperature below 4°C and in the dark until they are analysed. If this is not possible, then at least samples for BOD, coliforms, pesticides and other organics that are likely to volatilise **MUST** be kept at 4°C, and dark. Remaining samples can have no preservation. In the field, the best way to ensure that samples are kept cold is to pack them into insulated cool boxes containing either an ice/water mixture or a large number of ice packs. Thus sufficient cool boxes to contain a full day's sampling campaign should be available to each field operative that is required to take water quality samples.

Samples should be transported to concerned laboratory (level II or II+) as soon as possible, preferably within 48 hours. If samples are being brought to a Level I laboratory for the 'field determinations', they should be transported in less than 24 hours.

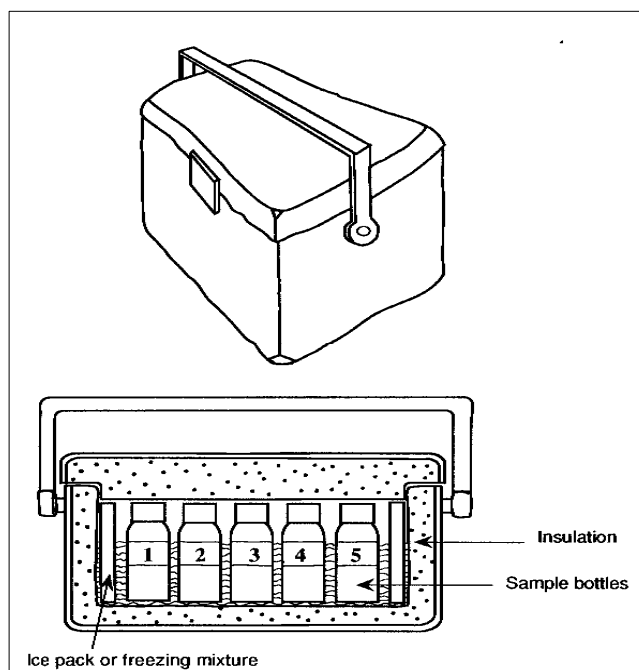

*Figure D.6: Insulated bottle carrier for water quality samples*

In addition to that specified above a field operative taking water quality samples will need certain other

## **Annex E: Documentation of groundwater monitoring – Examples of standard forms**

### ***Introduction***

A proper monitoring program should encompass:

- A monitoring handbook that documents procedures which must be followed to ensure good quality and integrity of the data collected
- A monitoring station file of each well that contains all important information
- A field report form sheet that must be filled out upon arrival at the site and contains all relevant information about the field work conducted

#### Monitoring handbook

When collecting monitoring data in the field, distinct procedures must be followed to ensure good quality and integrity of the data collected. This procedure must be laid down in a monitoring handbook. Such a handbook is different for each individual monitoring purpose and is therefore not included in this guideline. A handbook avoids that procedures are being followed differently by different staff members so that monitoring results may become incoherent or unusable.

#### Monitoring station file

A monitoring station file of each well must be available that contains all important information (name, coordinates and elevation, location sketch, photos, well drilling and design information, previous monitoring records, etc.; *Annex E-1*). A copy of the monitoring station file should be taken to the field in order to be able to identify the causes of problems.

#### Field report

Upon arrival at the site, a form sheet must be filled out that contains all relevant information about the field work conducted and some general information, such as for instance weather conditions, status of monitoring site, field measurements of T, pH, EC, etc., or whether maintenance works are required or not (*Annex E-2*). Before conducting the measurements or taking the readings from the recorder the intactness of the well has to be checked and documented. In case of quality monitoring a sampling protocol has to be prepared (*Annex E-3*).

## Annex E-1: Monitoring Station File

The following basic data should be made available for each groundwater level monitoring well. These data should be kept in a file in the office. The monitoring wells should be unmistakably marked in the field. It is recommended to include a sketch and photos of the site to facilitate retrieval of location.

Item	Unit	Remark
<b>Name</b>		
Well Identification No.		Unique code system for easy and unmistakable data retrieval using basin/area codes
Monitoring ID No.		Ditto
Name of Well		
Owner of Well		
<b>Location</b>		
East Coordinates	m	Local grid system
North Coordinates	m	Local grid system
Source of Data		Where data were obtained from
Type of Coordinate Determination		Acquired by leveling, single instrument GPS, Differential GPS, etc.
Elevation	m	
Source of Data		Where data were obtained from
Type of Elevation Determination		Acquired by leveling, single instrument GPS, Differential GPS, etc.
Governorate		
District		
Town/Village		
Location Name		
Location Description		
Location Sketch(es)		
Photo(s) of Location		
<b>Drilling Data</b>		
Drilling Rig(s)		
Drilling Type(s)		
Drilling Company/-ies / Agency/-ies		
Drilling Fluids Used		
Date Drilling Started		
Date Drilling Completed		
Total Depth	m	
Water strikes encountered at	m	
Loss of circulation encountered at	m	
Drilling Diameters from/to	m; mm or inches	
Cementings from/to & Materials	m	
Backfillings from/to & Materials		
Casing/Screens x from/to	m	
Casing/Screens x Diameters	in/mm	
Casing/Screens x Type & Materials & Slot Sizes		
Centralizers Positions	m	
Gravel Packs from/to	m	
Gravel Packs Types		



<b>Well Development</b>		
Date of Development		
Type of Development		
Duration of Development		
Equipment/Fluids used		
Volume and Source of Water (if applicable)		
Result of Development		
Company		
<b>Geophysical Borehole Logging</b>		
Geophysical Log x from/to	m	
Date of Logging		
Logging by (Company/Agency)		
Data available at		
<b>Pumping Test</b>		
Test x		
Type of Testing		Hydraulic Parameter Characterization / Capacity Test
Date of Testing		
Depth of Pump Installation		
Pump Type/Model Name		
Discharge at Step x		
Duration of Discharge x		
Distance to Aquifer Boundaries		
Distance to Nearest Other Well		Well that was monitored during pumping test
Static Water Level	m	
Reference Point		e.g. land surface/well head, etc.
Dynamic Water Level	m	
Other Parameters Monitored		
Well Loss		
Aquifer Loss		
Proposed Maximum Discharge	m <sup>3</sup> /h	depending on the locally used units
Specific Capacity	m <sup>2</sup> /h	depending on the locally used units
Results: Transmissivity	m <sup>2</sup> /h	depending on the locally used units
Results: Hydraulic Conductivity	m/s	depending on the locally used units
Method of Evaluation		
Results: Storage Coefficient		
Method of Evaluation		
Results: Specific Yield	m <sup>2</sup> /h	depending on the locally used units
Results: Leakage Factor	l/s	depending on the locally used units
Method of Evaluation		
<b>Geology/Lithology</b>		
Section x from/to	m	
Rock/Sediment Description		
Lithostratigraphic Classification		
(Age)		
<b>Hydrogeology</b>		
Aquifer x		
Aquifer Classification		Aquifer Name
Aquifer Type		Confined/unconfined/leaky/artesian
Penetration		Complete/partial
Top		
Bottom		

<b>Hydrochemical Composition</b>		
Data of Sampling		
Sample No.		
Laboratory No.		
Sampled by		Name/Agency
Field Measurements: pH	-	
Field Measurements: EC	µS/cm at reference temperature	
Field Measurements: T	°C	
Field Measurements: O <sub>2</sub>	mg/l	
Analysis Results: All Analyzed Parameters		
<b>Monitoring Equipment</b>		
Name/Model x for Data Registration		
Type of Data Registration		
Date of Installation		
Installed by		
Installation Depth	m	
Type(s) of Material		
Service Agency		Name, phone no., etc.
Name/Model x for Data Storage		
Service Agency		Name, phone no., etc.
Name/Model x for Data Transfer		
Service Agency		Name, phone no., etc.
<b>Constructions</b>		
Name/Type of Well Cap		
Type of Construction		e.g. Building/Fence/Telemetry Station with Solar Panel/etc.
Date of Construction		
<b>Well Rehabilitation</b>		
Rehabilitation x		
Date		
Method		
Duration		
Conducted by		
Specific Capacity before Rehabilitation		
Specific Capacity after Rehabilitation		
<b>Maintenance</b>		
Maintenance x		
Date		
Description of Problem		
Description of Solution		
Conducted by		

In addition a standard lithological log and a standard design diagram (as-built) has to be added to the file.

## Annex E-2:

### Groundwater Level Monitoring – Monitoring Field Report

Each time a groundwater level monitoring well is visited a monitoring field report should be filled out.

<b>Groundwater Monitoring Program “xyz”</b>	
Name of Agency and Responsible Division/Section	
Well Identification No.	
Monitoring Well No.	
Name of Well	
(Other Basic Data)	(e.g. coordinates, etc.)
Date of Visit	
Visited by	
Status of Monitoring Site	concerning borehole, equipment, construction, etc.; e.g. flooding of borehole (during a certain rainfall event) likely, float stuck during (dates), batteries empty, solar panel damaged, etc.
Last Maintenance	date
Maintenance conducted	
Description of Problem	
Description of Solution	
Last Rehabilitation	date
Water Level Indicated by Instrument	in m below reference point
Manual Measurement of Water Level	in m below reference point
Measured by Water Level Meter No.	ID no. of instrument
Data File Downloaded to	e.g. notebook xyz
File Name	unique file name
Remarks	e.g. maintenance/repair works required, water level corrected, instrument calibrated, etc.
Other Field Parameters	e.g. EC, pH, T, O <sub>2</sub>
Water Quality Sampling	yes/no, sample id no.

If a water sample is taken at the same time, a separate protocol should be completed (see *Annex E5-3*).

## Annex E-3: Sampling Protocol

<b>Sampling Protocol</b>	
Name of Monitoring Program	
Name of Institution	
Name of Responsible Monitoring Staff	
Sampling Ordered by	
<b>Location Data</b>	
Identification No.	
Name of Monitoring Site	
Name of Owner	
East Coordinate/ Latitude	
North Coordinate/Longitude	
Elevation (land surface)	
Elevation (reference point)	
<b>Borehole Data</b>	
Total depth	
Position of well screens	
Aquifer(s)	
Lithological description	
Inner Casing Diameter(s)	
<b>Well Purging</b>	
Type of Purging/Type of Pump	
Time Well Purging started	
Duration of Purging [min]	
Discharge [l/min]	
Depth of Pump Setting	
<b>Well Sampling</b>	
Sampling Date	
Static Water Level (before purging)	
Static Water Level (after purging)	
Discharge during Sampling [l/min]	
Sampling Device	
Number of Samples & Sizes of Samples	
Containment Type(s) & Material(s)	
<b>Field measurements</b>	
EC [ $\mu$ S/cm]	
pH	
Redox [mV]	
O <sub>2</sub> [mg/l]	
T [°C]	
Color	
Turbidity	
Odor	
<b>Sample Treatments</b>	
Filtration Method	
Mesh Size of Filter	
Samples Filtered	
Treatment Sample 1	
Treatment Sample 2	
Treatment Sample 3	
<b>Sample Conservation</b>	
Cooling to +4°C	Samples no.
Freezing to -20°C	Samples no.

<b>Sampling Protocol</b>	
<b>Storage</b>	
Name and Location of Temporary Storage Site for Sample x	
Duration of Storage (from – to) for Sample x	
Storage Conditions for Sample x	
<b>Laboratory</b>	
Name of Laboratory	
Analysis Date	
Laboratory Identification No.	
Analytical Methods	
Noticeable Results (e.g. above xyz Standard)	
Analysis Results entered (Name/Date)	

Photos, Sketch maps, Signature

## **Annex F: Operational costs – Examples from Europe**

### ***Introduction***

The installation and operation of a groundwater level monitoring network is a costly and time consuming task. The overall costs depend on the purpose of monitoring, the aerial coverage, the type of data recording and transfer, the monitoring frequency, the duration of operation, and other factors, e.g. the materials used, the chemical composition of the water and its aggressiveness towards certain materials.

The following different costs have to be distinguished:

- Costs for site selection (remote sensing, aerial photograph interpretation, geophysics);
- Drilling costs;
- Costs for well fittings;
- Costs for well development;
- Costs for pumping tests (step tests, constant discharge tests);
- Costs for monitoring data recording equipment including its installation;
- Costs for other required equipment (pumps, sampling devices, filtration, treatment, transport, storage, etc.);
- Costs for topographic survey (determination of coordinates and elevations);
- Costs for field surveys (including field equipment, cars, field allowances, etc.);
- Maintenance costs (well rehabilitation, etc.);
- Costs for water analyses (including sampling, preservation, transport, storage, etc.)
- Costs for data management, analysis, interpretation and reporting (hardware, software, personnel, printing/web-based publication, etc.);
- Costs for personal safety precautions;
- Training costs (internal, external);
- Costs for audits (internal, external).

Before establishing a monitoring network the overall costs for installation and the annual costs for operation have to be determined. This is important in order to provide that the allocated funds are not exceeded. The following tables list some typical costs which may be useful for general considerations concerning the selection of drilling and installation methods, monitoring and data transfer methods, instruments to be used, hard and software to be used, sampling/monitoring frequencies and durations, data processing methods, type and frequency of data publication, selection of and training needs for technical and scientific personnel, etc.

A detailed financial plan encompassing all proposed and planned monitoring activities will have to be prepared for a foreseeable time period. This plan may have to cover several stages of monitoring during which different monitoring needs are given. An example for such a financial plan is documented in Annex F (could also be included as a file or download link). At regular intervals the monitoring needs and the costs must be analyzed and the network should be optimized. A number of decision support tools have been developed over the past few years which help to formulate long-term cost-effective monitoring plans and reduce costs.

According to VAN BRACHT (2001) the costs for groundwater (level and quality) monitoring in the Netherlands are distributed as follows: data acquisition: 48%, maintenance: 18%, data management: 18%, depreciation: 16%. This calculation does, however, not take into account the installation and personnel costs.

Cost analyses in the framework of the RCRA program (Resource Conservation and Recovery Act, USA) have come up with average costs of 25% for sampling, 45% for analytical costs and 30% for

data management (HORSEY et al., 2004). This evaluation also neglects installation and personnel costs and may be typical only for monitoring of contaminated sites.

The Environment Agency (2002) has analyzed the costs of groundwater quality monitoring in the UK in order to provide guidance for the strategy concerning the establishment of a systematic national program for monitoring groundwater quality in England and Wales. For the improved network it is estimated that approximately 15% of the total annual cost will need to be allocated to field sample collection, 70% to analytical costs at the National Laboratory Service, and 15% to program management and data interpretation.

The three examples mentioned above and other experiences from the operation of groundwater monitoring networks show that there is a considerable difference in the annual costs between different programs.

When establishing a financial plan for a monitoring scheme, however, the 'additional' costs for audits, network improvement, well rehabilitation, maintenance, training, etc. should not be underestimated.

For some of the above mentioned costs it is difficult to give estimates, like e.g. personnel and training costs, personal safety costs, costs for topographic surveys, costs for water analyses, costs for data management, analysis, interpretation and reporting and costs for audits because these strongly depend on the local conditions. However, some general remarks concerning these aspects are necessary:

- *Personnel and training costs.* The responsible staff must be adequately qualified. Therefore qualification and training measures must be an integral part of a monitoring program. Training encompasses data acquisition methods (e.g. how to operate data loggers, how to maintain and rehabilitate monitoring wells, how to collect samples for water quality monitoring, etc.) and methods of data interpretation.
- *Personal safety costs.* Personal safety measures may be needed, e.g. in case of monitoring of contaminated sites. The involved personnel must be trained and mentally and physically fit to conduct the job. A good logistics must be provided, i.e. protective clothing and other special equipment must be available, the exposure to hazardous substances must be monitored, the health of the involved personnel must be monitored regularly, decontamination procedures must be followed, emergency equipment must be available and an emergency response and contingency plan has to be set up. A good overview on such health and safety considerations is given in NIELSEN (1999).
- *Costs for topographic surveys.* Costs for topographic surveys have dramatically decreased using GPS systems so that even in remote areas the determination of coordinates and elevations is affordable (e.g. using differential GPS). In this respect it is important to consider in advance which level of accuracy is needed so that the most appropriate and cost-effective method is chosen.
- *Costs for water analyses.* At the beginning of monitoring programs there may be a need for a more comprehensive list of parameters than actually needed in the long run. In order to reduce monitoring costs it is recommended to review the analysis parameters for each individual well in groundwater quality monitoring programs at regular intervals. A cost reduction may also be possible by selecting analysis methods which yield appropriate results at lower costs.
- *Costs for data management, analysis, interpretation and reporting.* A large share of the personnel costs fall into this segment. By establishing concise routine procedures and streamlining them some time after the beginning of a monitoring program time and money can be saved.
- *Costs for audits.* Audits may be necessary to conduct at regular time intervals in order to improve the monitoring program. There are different aims of audits: improvement of network density, improvement of procedures, improvement of evaluation and reporting procedures and improvement of cost-effectiveness (Annex F).

Tables F-1 to F-4 list a number of such costs referring to prices in Germany (modified after



MARGANE, 2004). They give an overview about the cost positions involved, but some positions of course depend on the local conditions which may be considerably different from those in Germany.

### ***Costs of drilling and well fitting***

*Table F1: Costs for Groundwater level monitoring (4-6" wells, different depths) - Drilling and well fitting costs*

Item	Costs in Euro
Mobilization (0-50 km, 50-100 km, 100-200 km)	1500, 2500, 3250
Installation of/demobilization from drilling site	750, 1500, 3000
Drilling costs, rotary, drilling depth 0-50 m, per m	35
Drilling costs, rotary, drilling depth 50-100 m, per m	40
Drilling costs, rotary, drilling depth 100-400 m, per m	40-50
Casing, galvanized steel, per m, 5 cm/10 cm/12.5 cm/15 cm diameter	10/27/55/70
Casing, stainless steel, per m, 10 cm/12.5 cm/15 cm diameter	180/200/220
Casing, PVC, per m, 5 cm/10 cm/12.5 cm/15 cm diameter	10/20/30/36
Screens, galvanized steel, screen slot openings 0.5 mm wide, per m, 5 cm/10 cm/12.5 cm/15 cm diameter	
Screens, stainless steel, screen slot openings 0.5 mm wide, per m, 10 cm/12.5 cm/15 cm diameter	210/230/260
Screens, PVC, screen slot openings 0.5 mm wide, per m, 5 cm/10 cm/12.5 cm/15 cm diameter	11/34/47/57
Cementation, per m <sup>3</sup> , incl. installation	40
Centralizers, per piece, material & installation)	20 (every 20 m)
Filter/gravel pack, per m, incl. installation	20
Seals (clay), per m, incl. installation	40
Counter filter, per m	20
Well development (clean-pumping)	500 + (depending on water level)
Bottom plug	15

The drilling of a standard groundwater level monitoring well in Germany of 100 m depth fitted with 4" PVC casing/screens at a location of up to 100 km from the drilling company's office thus would cost around 12,000 Euro.

### ***Costs of groundwater level monitoring***

*Table F2: Costs for Groundwater level monitoring (4-6" wells, different depths) – Costs for Monitoring Equipment and Installation*

Item	Costs in Euro
Well head	depending on type of installation
Automatic water level recorder (chart), unencoded	2,000 – 5,000
Automatic water level recorder, with encoding equipment	600 – 5,000
Pressure probes	600 – 2,500
Notebook/data readout device	1,000 – 1,500
Telemetry system using radio signal	upon request
Telemetry system using GSM	upon request
Telemetry system using satellite link	upon request
Construction Costs	depending on type of construction

**Costs of groundwater quality monitoring**

Costs for groundwater quality monitoring considerably differ from costs for groundwater level monitoring. The costs related to drilling, installation of casings and screens, well development and some basic field equipment are already documented above. However, in addition to these the following costs have to be considered :

Costs for

- Special casing/screen materials;
- Field equipment
- Personal safety precautions;
- Well purging;
- Sampling devices;
- Filtration;
- Sample containment;
- Sample treatment;
- Sample transport and storage; and
- Laboratory analysis.

These costs may become quite substantial, so that the costs of groundwater quality monitoring are generally much higher compared to the costs for groundwater level monitoring. These costs also depend to a large degree on the local conditions and regulations so that only limited guidance can be given here.

*Table F3: Costs for Groundwater Quality Monitoring (4-6“ wells, different depths) – Costs for Field Equipment*

Item	Costs in Euro
Water Level Meters 50 m/100 m /200 m/ 300 m/ 500 m	250/300/450/600/900 EUR
Micro Filters 0.45 µm (100 pieces) incl. syringe	depending on type of material: 50 – 500
Electric Conductivity Meter	700 – 1,400 (for instrument with 100 m cable)
pH Meter (with integrated ORP measurement; ORP – oxidation-reduction potential)	400 – 1,600 (for instrument with 100 m cable)
Oxygen Meter (dissolved oxygen)	700 – 1,400 (for instrument with 100 m cable)
ISE Meters (ISE – ion selective electrode)	between 200 and 700
BOD Measurement (BOD – biochemical oxygen demand)	(compare oxygen meter)
Portable Photometer (for measurement of selected parameters; compare chapter 5.3.5 of Part B of this report)	between approx. 1,000 and 4,000

Table F4: Selected Costs for Groundwater Quality Monitoring (6"/150 mm)

Item	Costs in Euro
source: German Water and Energy [ <a href="http://www.gwe-group.com">www.gwe-group.com</a> ] Casings/screens (PVC-U) per m (7.5 mm wall thickness)	26.4/39.5
Casings/screens (PVC-U) per m (9.5 mm wall thickness)	36.8/56.4
Screens (PVC-H wrought wire, thick wall construction)	115
Casings/screens (epoxy-coated steel - HAGULIT)	86/135
Casings/screens (Stainless steel) per m source: [ <a href="http://www.johnsonscreens.usfilter.com">www.johnsonscreens.usfilter.com</a> ]	prices depend on market prices for stainless steel
Casings/screens (HDPE) per m (6 m lengths)	15.1/27.4
Casings/screens (PTFE)	
source: Grundfos [ <a href="http://www.grundfos.com">www.grundfos.com</a> ] :	(prices depend on pumping lifts and pumping rates)
MP-1 pump	
SQE-NE pump	
SP-NE pump	around 2,500
Bailer	
1 l [ <a href="http://www.seba.de">www.seba.de</a> ]	650
Disposable (PVC) [ <a href="http://www.enviroequipment.com">www.enviroequipment.com</a> ]	3
Disposable (PE) [ <a href="http://www.hoskin.ca">www.hoskin.ca</a> ; <a href="http://www.enviroequipment.com">www.enviroequipment.com</a> ]	4
Disposable (HDPE) [ <a href="http://www.solinst.com">www.solinst.com</a> ; <a href="http://www.enviroequipment.com">www.enviroequipment.com</a> ]	
Disposable (Teflon) [ <a href="http://www.hoskin.ca">www.hoskin.ca</a> ; <a href="http://www.enviroequipment.com">www.enviroequipment.com</a> ]	
Point source bailer [ <a href="http://www.solinst.com">www.solinst.com</a> ]	9-16 no price available
Sample flasks (carbonate-silicate glass) per piece 0.1/0.25/0.5 l transparent	1.6/3.0/3.5
opaque	1.4/2.5/3.2
Sample flasks (PVC) per piece 0.5/1.0 l	1.6/2.3
Sample flasks (HDPE) per piece 0.1/0.5 l	0.65/1.1
Sample flasks (Teflon PFA) per piece 0.125/0.25/0.5 l	41/59/81
Gas detection [ <a href="http://www.compur.com">www.compur.com</a> ]	
Impact (detection of O <sub>2</sub> , combustibles, H <sub>2</sub> S, CO <sub>2</sub> )	1,100

**References:**

- Environment Agency (2002): Development of methodology for selection of determinant suites and sampling frequency for groundwater quality monitoring: Implementation Plan. – National Groundwater and Contaminated Land Centre Project NC/00/35, 18 p.; Almondsbury/UK.
- Horsey, H.R., Carosone-Link, P. & Loftis, J. (2004): Managing RCRA Statistical Requirements to Minimize Ground Water Monitoring Costs. – 7 p. [internet source: [http://idt.nicusa.com/sanitas/pdfs/mng\\_rcra.pdf](http://idt.nicusa.com/sanitas/pdfs/mng_rcra.pdf)]
- Margane, A. (2004): Guideline for Groundwater Monitoring. – Technical Cooperation Project ‘Management, Protection and Sustainable Use of Groundwater and Soil Resources in the Arab Region’, Technical Report Vol. 7, prepared by BGR & ACSAD, 318 p.; Damascus.
- Nielsen, D.M. (1991): Practical Handbook of Ground-Water Monitoring. – 717 p.; Boca Raton/USA (Lewis Publ.)
- Van Bracht, M. J. (2001): Made to Measure – Information Requirements and Groundwater Level Monitoring Networks. – PhD thesis, Univ. Amsterdam, 210 p.; Amsterdam.

## **Annex G: Audits and groundwater monitoring network optimisation**

There are a large number of reasons which may cause problems in groundwater level monitoring data collection and their interpretation. In order to minimize such problems it is useful to analyze at regular intervals the entire monitoring procedure and the causes for failures.

The most common reasons for failures of groundwater level monitoring in developing countries are (modified after MARGANE 1995):

- The status and functionality of a monitoring site is not always thoroughly checked;
- Hand measurements are not always conducted when required (e.g. when the float was stuck);
- Unreliable recordings of manual and other measurements (due to writing/reading mistakes, wrong reference points, wrong use of or faulty measuring devices, etc.);
- Irregular and untimely field measurements and maintenance (e.g. untimely exchange of batteries: the dates batteries were last exchanged should be marked on the power pack and noted in the field report; only high quality batteries should be used);
- Vandalism (e.g. due to ineffective protection);
- Missing or lost field reports;
- Measurements are out of measuring range of installed equipment.

Another objective of audits is to optimize the monitoring network concerning network density, concerning the data collection, evaluation and publication process as well as concerning the operational costs. A proposal for this optimization process is shown in *Table G-1* (based on MARGANE, 2004, LAWA 1999a, 1999b, EPA 2004).

A number of concepts have been developed over the past few years in order to reduce costs in monitoring programs. Decision support tools for the design and optimization of long-term cost-effective monitoring networks have e.g. been introduced by the US Army (AFCEE, 1997) for monitoring at remediation sites, reducing the costs by around 30-60%. An improved monitoring scheme may be reached refining the following parameters.

Table G1: Optimization Process for Groundwater Monitoring Schemes

<b>Optimization of Network Functionality and Density *</b>
<ul style="list-style-type: none"> <li>• Establishment of well inventory and control of monitoring functionality</li> <li>• Control of suitability of well design and maintenance/rehabilitation requirements</li> <li>• Control of hydrogeological assumptions (aquifer unit, aquifer geometry, hydraulic parameters, suitability of monitoring location and monitored depth interval, etc.)</li> <li>• Determination of reference monitoring wells</li> <li>• Determination of optimal locations</li> <li>• Determination of redundant and unusable monitoring wells</li> <li>• Determination of new monitoring sites</li> </ul>
<b>Optimization of Management Procedures</b>
<ul style="list-style-type: none"> <li>• Control and refinement of monitoring frequencies</li> <li>• Control and refinement of analytical parameters and analytical quality assurance needs</li> <li>• Control and refinement of data transfer methods and procedures</li> <li>• Control of data plausibility check procedures</li> <li>• Control of suitability and adaptation of data storage and processing methods and procedures</li> <li>• Control of data exchange procedures with other institutions</li> <li>• Control and refinement of data publication methods and procedures</li> </ul>
<b>Optimization of Field Survey Procedures</b>
<ul style="list-style-type: none"> <li>• Control and refinement of data collection methods and procedures (manual/automatic recording, telemetric data transfer, parameters recorded, instruments used, etc.)</li> </ul>
<b>Optimization of Costs</b>
<ul style="list-style-type: none"> <li>• Control of analytical costs (cost-effectiveness ensuring good quality of data)</li> <li>• Control of materials and equipment costs</li> <li>• Control of management costs including costs for audits</li> <li>• Control of labor costs including costs for training</li> </ul>

\* Remark: this optimization process starts with an evaluation whether a monitoring well still meets the monitoring criteria which were or should be defined in the monitoring concept.

## References:

- AFCEE (1997): Long-Term Monitoring Guide – Version 1.1. –Air Force Center for Environmental Excellence, 40 p; Brooks Air Force Base/USA. [internet source: <http://www.afcee.brooks.af.mil/products/rpo/default.asp>]
- EPA (2004): Guidance for Monitoring at Hazardous Waste Sites: Framework for Monitoring Plan Development and Implementation. – OSWER Directive, 9355.4-28; Washington.
- LAWA (1999a): Empfehlungen zu Konfiguration von Messnetzen sowie zu Bau und Betrieb von Grundwassermessstellen (qualitativ). – 32 p.; Berlin/Germany (Kulturbuchverlag).
- LAWA (1999b): Empfehlungen zur Optimierung des Grundwasserdienstes (quantitativ). – 36 p.; Berlin/ Germany (Kulturbuchverlag).
- MARGANE, A. (1995): Groundwater Resources of Northern Jordan, Vol.2, Part 2: Monitoring of Groundwater Levels in Northern Jordan. - Technical Cooperation Project 'Advisory Services to the Water Authority of Jordan', BGR & WAJ, BGR archive no. 112708, 71 p., 3 app., 3 maps; Amman.
- MARGANE, A. (2004): Guideline for Groundwater Monitoring. – Technical Cooperation Project 'Management, Protection and Sustainable Use of Groundwater and Soil Resources in the Arab Region', Technical Report Vol. 7, prepared by BGR & ACSAD, 318 p.; Damascus.

# Appendix H: An example of groundwater monitoring in Jordan

## Table of contents

<b>1</b>	<b>Water resources and WRM in Jordan .....</b>	<b>2</b>
1.1	Groundwater resources .....	2
1.2	Organisation of groundwater management and monitoring .....	2
<b>2</b>	<b>Groundwater development in Amman-Zarqa basin .....</b>	<b>4</b>
2.1	General description of the basin .....	4
2.2	Groundwater resources and observed trends .....	6
<b>3</b>	<b>Evaluation of the groundwater monitoring programme .....</b>	<b>9</b>
3.1	Groundwater Level Monitoring Network .....	9
3.1.1	<i>Monitoring objectives</i> .....	9
3.1.2	<i>Previous status of the monitoring network</i> .....	9
3.1.3	<i>Improvement of the Monitoring Network</i> .....	9
3.2	Ground Water Quality Monitoring Network .....	10
3.2.1	<i>Monitoring Objectives</i> .....	10
3.2.2	<i>Previous status of the monitoring network</i> .....	11
3.2.3	<i>Improvement of the Monitoring Network</i> .....	11
3.3	Data collection and data quality .....	11
<b>4</b>	<b>References .....</b>	<b>13</b>



# 1 Water resources and WRM in Jordan

## 1.1 Groundwater resources

Jordan's water resources consist primarily of surface and ground water. Renewable water resources are estimated at about 780 million cubic meters (MCM) per annum, including ground water (275 MCM/year distributed among 11 basins) and usable surface water (505 MCM/year distributed among 15 catchment basins). An additional 143 MCM/year of groundwater is estimated to be available from fossil aquifers. Brackish aquifers are not yet fully explored, but at least 50 MCM/year is expected to be available for urban uses after desalination (JICA, 1995). Treated wastewaters are being used on an increasing scale for irrigation, primarily in the Jordan River Valley, and can provide at least an additional 80 MCM/year until the year 2010 (El-Naser and Elias, 1993).

Ground water is the major source of water supply in the country. 12 groundwater basins have been identified in Jordan (see Figure H1). Most basins are comprised of several aquifer systems.

Jordan's water budget for 2003 was approximately 810 MCM, of which more than 520 MCM was provided from groundwater sources (433 MCM from renewable; 87 MCM from non-renewable). The long term annual recharge of groundwater in Jordan is approximately 275 MCM; consequently, about 245 MCM/year was overpumped from groundwater resources in 2003.

Surface waters contributed approximately 36% (290 MCM) to the 2003 water budget. Approximately 75 MCM of wastewaters were reused in 2003 (9% of the water budget). In the last decade, treated wastewater has become an important water resource for restricted uses and has been actively incorporated into the strategic planning of water policy makers in the country.

Water scarcity is the single most important natural constraint to Jordan's economic growth and development. Rapid increases in population and industrial development have placed unprecedented demands on water resources. Total demand is approaching one billion cubic meters per year, which approximates the limit of Jordan's renewable and economically developable water resources. For several years, renewable ground water resources have been withdrawn at an unsustainable rate. In addition, surface and ground water quality in some areas is deteriorating. Current water demands are not being met satisfactorily throughout the country (both spatially and temporally), and the costs of developing new water resources are rising rapidly.

## 1.2 Organisation of groundwater management and monitoring

In the Hashemite Kingdom of Jordan, The Ministry of Water and Irrigation (MWI) is the responsible governmental institution, for managing and supervising the water resources (ground & surface) quantity and quality. Upgrading and rehabilitation of the monitoring network in the Amman-Zarqa Basin (AZB) is one of the important activities of the Water Resources Monitoring Division in the Ministry. Also, analyzing the monitoring data is the responsibility of the Water Resources Studies and Planning Department. In addition, some wells are monitored (in most cases for relatively short time periods) by projects implemented in the MWI, WAJ, and Royal Scientific Society (RSS), Higher Council of Science and Technology (HCST) or other. All groundwater level monitoring data is stored in the MWI data base.

The groundwater quality monitoring program includes both chemical and bacterial parameters. Monitoring is performed from the year 1970 and since 1984 groundwater quality monitoring has been conducted by the WAJ. After 1998 the monitoring of the water supplies is done by the WAJ, the monitoring of the countrywide observation wells by the MWI.

All chemical data are stored in the MWI data base. The results of bacterial analysis however are stored in the data base at WAJ laboratory. Recently both databases were connected to one another. The reason for the existence of these two separate databases in the past was that the latter is responsible for controlling the suitability of drinking water whereas the former is responsible for controlling the general groundwater quality.

Yearly a monitoring report is prepared by the Groundwater Monitoring Division for interpretation of the data, and to specify the critical water level declined areas and groundwater quality deterioration. In most groundwater projects in MWI the interpreted and the new available monitoring data have been used to evaluate the current water resources and to build up the new strategies for sustainability and future planning.

The organizational structure of the Groundwater Monitoring Division and the number of technicians and hydrogeologists appears to be adequate to fulfil the present and future tasks. Part of the technical equipment (e.g. automatic water level recorders, spare parts, water level indicators, field vehicles) is insufficient and needs to be replaced.

## 2 Groundwater development in Amman-Zarqa basin

### 2.1 General description of the basin

The Amman-Zarqa basin is one of the largest developed areas in Jordan. It is also the fastest growing region both industrially and in terms of population. New industries and irrigation projects are being implemented in the area.

The Amman-Zarqa basin extends north to the Syrian borders, the Azraq basin to the east, Yarmouk basin to the northwest, and Amman area to the southwest. The Amman-Zarqa Basin covers 4710 km<sup>2</sup> of area, 468 km<sup>2</sup> of which are in Syria, (see Figure H1).

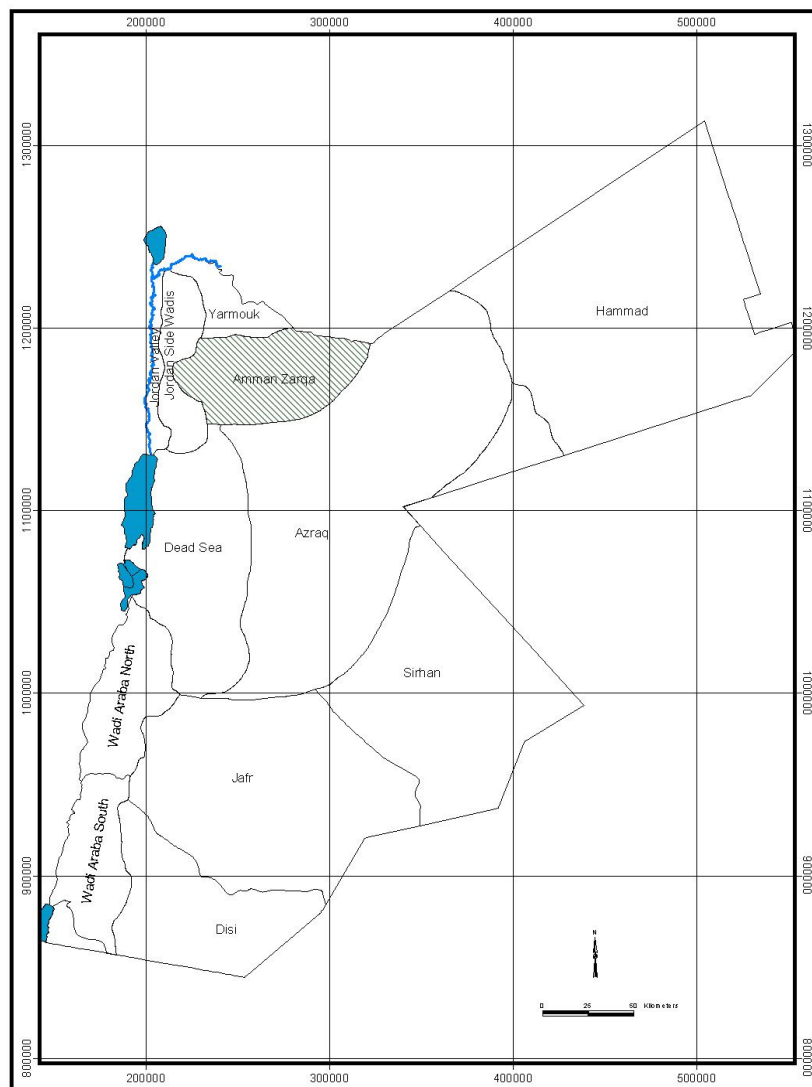

Figure H1: Groundwater Basins in Jordan, Location Map of the Study Area

The morphology of the area is characterized by a hilly area with moderate to high slope gradients. Elevations range from about -50 m above sea level (asl) in the western part of the catchment area to about 1200 m (asl) near the Arab Mountain.

The topography reflects the geology consisting mainly of a basaltic mount that slopes down to a central, gently rolling plateau bounded from north and south by rugged and dissected limestone hills. The climate is semi-arid and characterized by cold humid winter with lower temperatures including moderate frosts during the nights and warm dry summer. According to the 50-years mean annual rainfall map, rainfall ranges between 100-500mm. The mean monthly surplus volumes are in December, January, February and March. Average evaporation constitutes approximately 90% of the total rainfall (WAJ, 1989). Average estimated infiltration rate is approximately 4-10% (WAJ, 1989).

Different hydrogeological units can be distinguished, varying both in size and (hydro)geological composition (see also Figure H2).

- The Zarqa Aquifer (Z)
- The Kurnub Aquifer (K)
- The Lower Ajlun Hydrogeological System (A1/6)
- The Nau'r Aquifer (A1/2)
- The Fuheis Aquitard (A3)
- The Hummar Aquifer (A4)
- The Shueib Aquitard (A5/6)
- The Amman-Wadi Sir Aquifer System (B2/A7)
- The Muwaqqar Aquitard (B3)
- The Rijam Aquifer (B4)
- The Basalt Aquifer (BS)

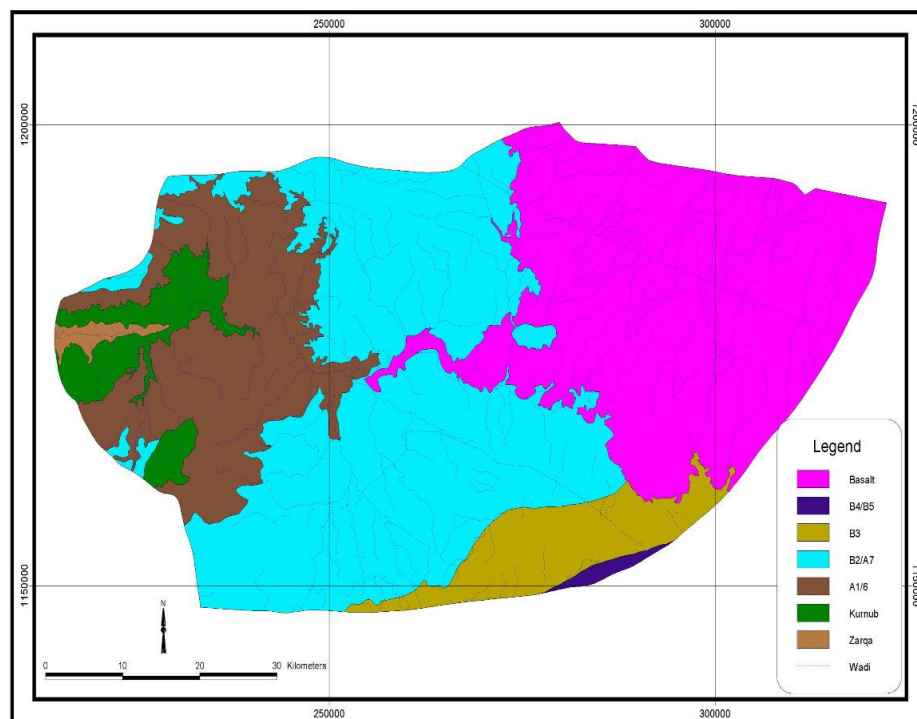

Figure H2: Outcropping formations in the study area

The B2/A7 group forms the major and most important aquifer in Jordan. This aquifer composed of karstified carbonate rocks represented by massive bedded limestone and cyclic deposits of chalk,

phosphate, limestone and chert. It receives the highest amount of modern recharge and is considered to be the principal source of fresh water for domestic as well as for irrigated agriculture in the Plateau. Groundwater from the Amman recharge mound flows in four directions as drawn in the map with Piezometric heads (see Figure H3). Recharge occurs in the western highlands and the estimated total recharge within the basin is about 40-45 MCM/y. Prior to aquifer depletion, an additional amount of about 23 MCM/y used to be transferred to the B2/A7 from the basalt aquifer in the upper Zarqa valley area.

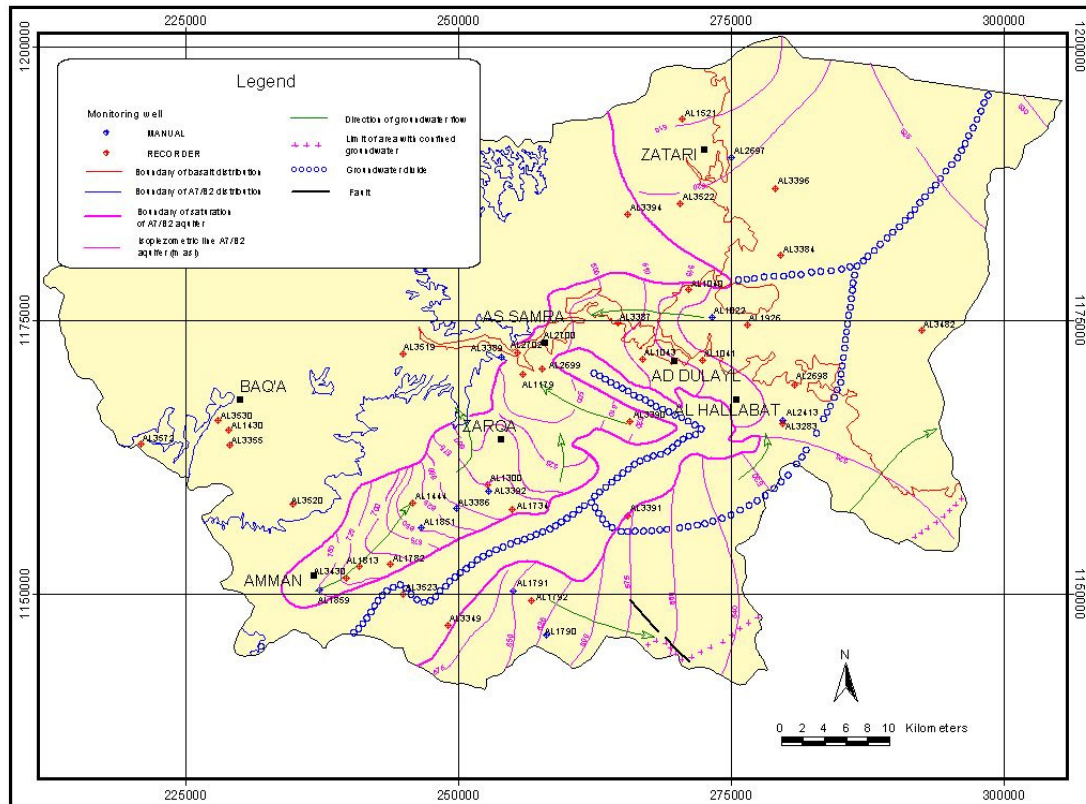

Figure H3: Piezometric Map of the A7/B2 Aquifer and Locations of Groundwater Level Monitoring Wells

## 2.2 Groundwater resources and observed trends

Groundwater represents the main source of water supply in the Amman Zarqa basin. Most of the groundwater exists and is being abstracted from the Basalt and B2/A7 layers within an area enclosed by the saturated limit of the B2/A7. This area includes the highest concentration of wells where depletion and deterioration in water quality has reached to critical stages. Abstraction in Amman-Zarqa basin started in mid sixties (1965: 8.46MCM) and increased continuously to reach around 140MCM in 2003. The estimated long term annual recharge is approximately 70.0MCM.

Monitoring of water resources provides the basic data required for planning and policy analysis, determination of safe yield and predictive analysis as well. Based on that, an integrated water quantity and quality monitoring network is essential and important to understand the present and changing status of water resources, and to define and enforce measures to implement policies with regard to water use.

The recent groundwater development has its impact on the groundwater system for both groundwater quantity and quality.

*For groundwater level:*

- In the late 70's and early 80's, declines in water levels in the basalt and in the B2/A7 aquifer in the Dulayl, Hallabat and Mafrqa areas were noticed in both government and private wells. The extent of the decline and annual rate of decline varies considerably. Declines in water level of the B2/A7 aquifer range between **0.67m and 2.0m per year**.
- The A4 Aquifer, which is partially confined in the basin and was known for its springs, is no longer artesian. The decline in water level is known to have exceeded **70 meters** in Ain Ghazal, north of Amman.
- The A1/2 Aquifer did not experience any significant decline in its water level in the basin. Springs from this aquifer on the western part of the basin are still flowing.
- The Kurnub Aquifer in the Baqa and Ain el Basha areas is excessively depleted. The wells are very close to each other (150-500m). A total decline of water level in this aquifer is about **70 meters** during the last 30 years.
- Declines in the water levels of the Zarqa aquifer have not been observed.

*For groundwater quality:*

Prior to groundwater overdraft, historical data up to 1970 show that groundwater in all aquifers of the Amman-Zarqa basin was of fairly good quality and that it was suitable for all uses. In the late 70's, both private operators and the government started deepening wells, especially in the B2/A7 and the basalt aquifers, which were the main sources of water supply in the basin for domestic and irrigated agriculture. Since then, the decline of water levels was accompanied by deterioration in water quality as can be seen in the time series graph (see Figure H4).

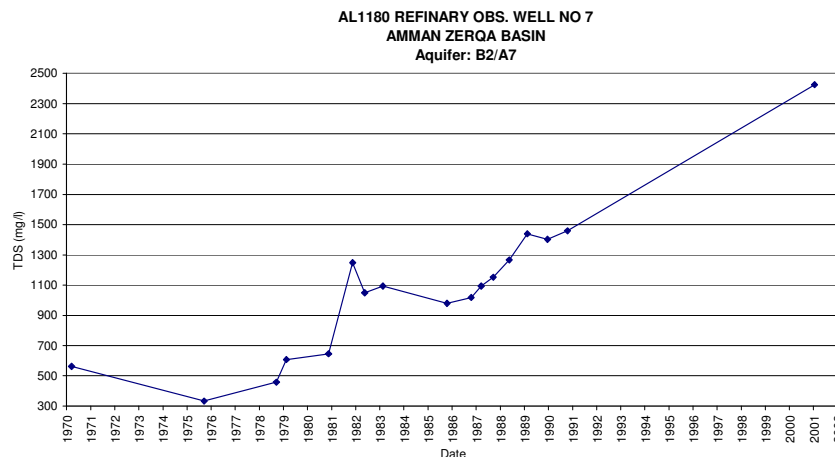

Figure H4: Time series of TDS increase over three decades

Deeper aquifers of lower quality were penetrated by many wells and production from more than one aquifer resulted in the disturbance of the hydraulic equilibrium. The following is a brief description of the chemistry of groundwater in the Amman-Wadi Sir Aquifer (B2/A7).

Prior to excessive abstraction, the TDS value ranged from 260 to 680 ppm, and the water type was calcium and magnesium bicarbonate. Nowadays, a salinity build-up is occurring in the north, north-east and eastern part of the basin. In some private wells in the north-east, TDS currently exceeds 2700 ppm.

In 2001, Associates in Rural Development (ARD) through a cooperation project with MWI carried out study in AZB to assess the impacts of over pumping on the groundwater and to analyze the aquifers behaviour to present and future changes in abstraction pattern.



### 3 Evaluation of the groundwater monitoring programme

In 1994, based on the analysis of the available water level monitoring data, the Water Quality Conservation Project through United States Agency for International Development (USAID) in cooperation with MWI, participated in rehabilitating and upgrading the monitoring system in the AZB through drilling a series of groundwater monitoring wells, rehabilitation / installation of new monitoring stations. In 1995, The German Federal Institute for Geosciences and Natural Resources (BGR) in cooperation with the Water Authority of Jordan (WAJ) through a technical cooperation project produced a report about monitoring of Groundwater levels in Jordan. In this chapter the results of the evaluation are given.

#### 3.1 Groundwater Level Monitoring Network

##### 3.1.1 Monitoring objectives

Most monitoring wells objectives in Jordan are based on long term movement of the groundwater table, which is necessary for groundwater simulations and modelling surveys, in order to define the regionally effective specific yield of aquifers and to calibrate the required hydrogeological models. Therefore, these data will be used to study the changing in the water balance of a groundwater resource and serve as a planning tool for groundwater management.

##### 3.1.2 Previous status of the monitoring network

The groundwater monitoring system in the AZB includes static water level monitoring wells (SWL), dynamic groundwater monitoring wells (DWL) and groundwater quality monitoring wells. The historical development of the network is given in Table H1.

Table H1: Historical development of the monitoring network

Year	Wells				
	Total number country	Basin	Static (SWL)	Dynamic (DWL)	Discontinued
1977	32	11			
1994	92	18			
2004	208	78	47	10	21

##### 3.1.3 Improvement of the Monitoring Network

By previous evaluations it was recognised that the monitoring network was inadequate to meet groundwater resources management needs. Recently all observation wells have been evaluated in respect to the purpose of monitoring, the location, the well design, and the technical status of the monitoring facilities in order to determine at which sites measurements should be continued and where they should be terminated and recommendations for additional wells.

A two phases **rehabilitation** program was conducted for eight SWL monitoring wells, starting in the year 2000. Unfortunately the rehabilitation of three wells failed because they were filled with stones and other materials.

The wells selected for rehabilitation were considered important for the network because of several reasons. These wells:

- are located in an important agricultural/ Industrial area with recognizable water consumption;
- have to monitor the effect of the industrial sector activities, on the groundwater resources quantity and quality;
- are located where highest groundwater consumption for agricultural demands is recorded.



*Figure H5: Rehabilitation of a water level monitoring well in AZB.*

In addition, a maintenance program by MWI/ARD was conducted in May-2001 for 17 monitoring wells in the basin and included the installation of shelter boxes on concrete bases for six wells and external maintenance, include re-painting and change the shelter box locks for 11 wells.

Based on the analysis of the available water level monitoring data, it is recommended to **discontinue** 21 wells from groundwater level monitoring network; 14 monitoring wells because of their proximity to operating monitoring wells and 7 wells, which were originally drilled for monitoring purposes, but are presently used for production.

In order to cover the data gaps in the northeastern part of the AZB, it is recommended to **drill two new** wells, to penetrate the B2/A7 aquifer. Also, it is recommended to drill a well in Jarash area to penetrate the A1/A2 aquifer.

## 3.2 Ground Water Quality Monitoring Network

### 3.2.1 Monitoring Objectives

The objective of groundwater quality monitoring is the supervision of groundwater quality throughout the basin. The results give information about the condition of groundwater quality, among other about long-term trends or about the impact of contaminants on the aquifer.

### 3.2.2 Previous status of the monitoring network

The AZB water quality monitoring network includes 114 wells, 71 operating and 43 presently not active. Measurements were suspended at the non active sites because they are very close to other monitoring wells and did not provide any additional information. Most wells and springs are monitored for common groundwater parameters such as electrical conductivity (EC), pH-value, total hardness,  $\text{Ca}^{2+}$ ,  $\text{Mg}^{2+}$ ,  $\text{Na}^+$ ,  $\text{K}^+$ ,  $\text{HCO}_3^-$ ,  $\text{Cl}^-$ ,  $\text{SO}_4^{2-}$ ,  $\text{NO}_3^-$ , and recently iron and sulphur. Additional bacteriological parameters (total coliforms, faecal coliforms) are measured on a regular schedule for wells and springs used for domestic water supply. Other constituents, such as heavy metals, organic solvents or gasoline additives are monitored in some areas also.

According to the yearly monitoring report by the Groundwater Monitoring Division, an increase of salinity and nitrate was observed in 2003 in the AZB.

### 3.2.3 Improvement of the Monitoring Network

Review of the water quality monitoring network indicates the need for **reactivating** 26 monitoring wells focusing on well field locations.

The review of distribution of the water quality monitoring network in AZB, indicate the lack of monitoring wells in both north Badia and Zatari areas. It was recommended to include 10 **new wells** to the water quality monitoring network.

It was recommended to **discontinue** 32 water quality monitoring wells, which are located in the proximity of operating monitoring wells.

## 3.3 Data collection and data quality

The 'Groundwater Monitoring Section' needs to continue correcting and checking the collected data in order to improve the required quality of the monitoring data sufficiently. This should be one of the main duties of the responsible hydrogeologists.

There are several problems due to which the monitoring results are still unsatisfactory related to technical, organisational but also training and financial deficiencies.

#### *Technical deficiencies*

- Often monitoring wells have not been drilled and were **not designed for this particular purpose**. In many cases boreholes have been turned into observation wells because of insufficient productivity. In such observation wells water level measurements might not be representative for water level fluctuations in the aquifer (wrong location of the well, wrong placement of the screens, corrosion or encrustation of the screens, etc.).
- In some observation wells, **the monitoring aquifer is not clear**. Sometimes, the drilling penetrates more than one aquifer
- Some of the **recorders get stuck** frequently because of insufficient maintenance and problems caused by the (not vertical) well construction or other technical problems leading to not representative measurements.
- Frequently recorders have been **stolen or vandalized** as they are sometimes not protected sufficiently by a metal box and locks.
- Wells used for manual measurements are not sufficient protected. A small hole is welded into the cap of the casing as a port for lowering a water level indicator into the well. Often wells have been plugged with stones since these port holes are **not protected** and wells are freely accessible.

*Organisational deficiencies*

- Normally, the charts of the recorders **should be changed monthly**. The maximum time range of most of the recorders in use in Jordan is 32 days. Because of lack of cars or for other reasons, this condition are not always met.
- Maintenance of the recorders is carried out by one person is in charge of repair work for all kind of instruments used in monitoring. The recorders have to be brought to his office. Apparently this is the reason that **maintenance is not undertaken often and properly enough**. Maintenance by the field technicians is inefficient. Often they are not equipped with the necessary tools and spare parts. Often it has been observed for instance, that the ink was completely dry (sometimes for several months) or was flowing too much at certain times because the ink cartridge was not maintained. In some cases the original graph has therefore, been replaced by a hand-drawn graph.
- In most cases, only the water level of the day at which the chart of the recorders was changed, was entered into the data bank. Normally this represents a time interval of about one month. Water level fluctuations are often relatively high due to pumping in nearby wells or recharge events. The **time intervals** used for the data bank records should therefore be much shorter in some cases.
- In some areas the **continuity** of groundwater level monitoring is insufficient. Some monitoring wells have been converted to production wells temporarily or permanently at times of water shortage. In some areas groundwater level monitoring was shifted several times from one well to another.
- The incoming field data as well as the data entered to the database are mostly not **checked** sufficiently. Many of the hydrographs in the data bank had to be corrected considerably. In general, evaluation of the original recorder charts needs to be improved.
- Proper **field reports** of the technicians are not available and information on water level indicator measurements, pumping in nearby wells, reasons for malfunction of the recorders, maintenance requirements, reasons for sudden water level fluctuations etc. are rarely recorded on the charts. This makes it difficult or impossible to interpret what the reason for certain fluctuations may have been.
- Samples for groundwater quality are collected on **different schedules**, depending on the purpose and the constituents that are being monitored. In the past sampling was often imperfect (non reliable data, data gaps), so that historical data can only be used to a limited extent.
- The recorder measurements should be controlled by **hand measurements** every time the charts are changed. In reality, hand measurements are rare and performed too irregularly (sometimes less than once a year).
- Unfortunately, even many manual measurements are **unreliable** (reading errors, addition subtraction mistakes) since water level indicators were often cut for repair and have been shortened, writing mistakes, and lack of information on reference points for the measurements.

## 4 References

- Hobler, M., et al. (1991): Groundwater Resources of Southern Jordan, Vol. 1 5. Federal Institute for Geosciences and Natural Resources (BGR), Project No. 86.2068.4 and No. 88.2180.3, Report No. 108652 and 107375; Hannover.
- Howard Humphreys & SONS (1983): Monitoring and Evaluation of the Amman-Zerqa Aquifers. - Unpubl. Rep. prepared for Amman Water and Sewerage Authority; Amman
- JICA (2001) : Water Resources Management Master Plan – Final Report, Vol. I., Amman
- Margane, A., et al. (1995): Groundwater Resources of Northern Jordan, Vol. 2. – Part 2. Rep. Federal Institute for Geosciences and Natural Resources (BGR), BMZ-Project No.: 89.2105.8 , File No. 12548/94 ; Hannover.
- Ministry of Water and Irrigation (2003): Water information system. Amman, Jordan
- Hydrometeorological Stations Monitoring Upgrade Plan. Water Quality Improvement and Conservation Project. 1997.
- Water Quality Monitoring System Upgrade Plan-Appendix D-Water quality Improvement and Conservation Project. 1995.
- Water Quality Monitoring System Upgrade Plan-Appendix E-Water quality Improvement and Conservation Project. 1995.
- Abu Ajamieh, M.M., 1989. Assessment of Brackish Groundwater in Jordan. A report submitted to the USAID and to the MWI by Development Alternatives, Inc.
- AHT and BGR, 1977. National Water Master Plan of Jordan, Volume IV: Annexes III-VI
- Parker, D.H., 1970. Investigation of the Sandstone Aquifers of East Jordan. AGL: SF/JOR9, Technical Report 2, FAO, UNDP.
- National Water Master Plan of Jordan, 1977. (Groundwater Resources Volumes)
- Natural Resources Authority of Jordan (NRA): Open file reports.
- Water Resources Authority (WAJ): Annual Reports of 1989- 2003.
- Associates in Rural Development (ARD), 2001. Rehabilitation and Upgrade of the Groundwater and Wadi Flow Monitoring Networks for Amman Zarqa Basin.
- JICA (1996): The Study on the Improvement of the Water Supply System for the Zarqa District in the Hashemite Kingdom of Jordan (Final Report).